

Height adjustable unit for Ropox Toilet Supports



User manual

This leaflet should always be kept with the product.

Content

1. Key to symbols	3
2. Safety	3
2.1 Product labelling.....	5
3. General requirements	6
3.1 Product information	6
3.2 Product description	7
3.3 Application purposes	7
3.4 Suitable operator	7
3.5 Product dimensions.....	7
4. Instructions for use	8
4.1 Mounting interfaces	8
4.2 Installing the product	9
4.3 Installation of toilet support	11
4.4 Operating the product – quick release	13
4.5 Operating the product – without quick release.....	14
5. Cleaning	15
5.1 Pre-approved disinfectants	15
6. Maintenance	15
7. Environmental considerations	16
8. Accident/incident reporting	16

1. Key to symbols

Warning Indication of a potentially dangerous situation. If not avoided, it can result in serious injury or death.	
Caution Indication of a potentially hazardous situation that may result in minor or moderate bodily injury. The symbol is also used to warn of improper use.	
Important This symbol draws attention to the correct use and handling of the product.	

2. Safety

	<p>This manual must be read and understood before use. Always keep this manual close to the product.</p> <p>The use, installation and service of this product must be carried out in accordance with this manual to avoid dangerous situations that could lead to personal injury.</p> <p>Never use the product in any way other than as described in this manual. Any non-compliance may result in personal injury, dangerous situations and/or damage to the product.</p> <p>The person installing and using this product either as operator or patient must have access to the necessary safety information in this manual.</p>
---	--



Do not carry out repairs, disassembly or assembly, own additions, adjustments or modifications to the product beyond what is described in this manual. These must be carried out by Ropox authorised personnel. Do not perform service when the product is being used by a patient.

This appliance may be used by children aged 8 years and above and persons with reduced physical, sensory or mental capabilities or lack of experience and knowledge if they have been given supervision or instruction concerning safe use of the appliance and understand the hazards involved. Do not allow children to play with the appliance.

Cleaning and user maintenance must not be carried out by children without supervision.

Do not use the product if it is faulty or damaged until it is repaired or replaced.



The information in this manual is based on correct installation in accordance with the installation instructions for this product.

Ropox cannot be held responsible if the product is used in a way that differs from that stated in this manual and/or installation instructions.

Ropox reserves the right to change this manual and reference documents without prior notice.

2.1 Product labelling

Ringstedgade 221, DK 4700 Næstved
ROPOX™ +45 55750500
 Info@ropox.dk
 Ropox Height Adjustment for Toilet Support Arms
 Wall mounted, 20 cm stroke, quick release

ITEM NO: 40-40450-1
 MAX LOAD: 250 kg
 Serial No: N10-xxxx
 01-01-25

UK CA CE

ROPOX™ WEB.: www.ropox.dk

Ropox A/S,
 Ringstedgade 221, DK- 4700 Naestved
 TLF: +45 5575 0500, E-mail: Info@ropox.dk

Transport & storage



	This product is CE marked in accordance with: European Medical Devices Regulation (EU)2017/745 Council Directive 2011/65/EU, RoHS
	Manufacturer's name and address
	Production date
REF	Item number
SN	Serial number
	Consult manual before use
	Refer to the manual for important safety-related information, warnings and precautions.
	Do not dispose of as unsorted municipal waste. The product must be returned to a suitable recycling centre.
	Operating and storage temperature must not exceed 5-40C°.
	Read the instruction manual before use

3. General requirements

3.1 Product information

Producent:	Ropox A/S Ringstedgade 221, DK-4700 Næstved +45 55 75 05 00 Email: Info@ropox.com		
Variants	Item number	Model	UDI
	40-40450 40-40451	Quick release Requires tools	05707581014802 05707581014819
Life expectancy	5 years		
MDR Class 2017/745	Class I		
Intended environment	This product should only be used in: Professional healthcare Private homes		
Max. user weight according to DS/EN ISO 17966:2016	250 kg		
Height adjustment	200mm		
Temperature range	-5°C to +40°C Transport and storage +5°C to +40°C In use		
Materials in contact with patient	Components Clamping handle Front plate End caps	Material description Cast zinc with antimicrobial paint Aluminium with antimicrobial paint ABS with antimicrobial additive	

3.2 Product description

The height-adjustable unit allows for easy height adjustment of Ropox Toilet Supports, providing optimal comfort when in use.

3.3 Application purposes

For users who need support to sit down and get up from the toilet, Toilet Supports are a great disability-friendly aid. People with limited mobility can use the Toilet Supports to support themselves when moving from standing to sitting and vice versa. The height-adjustable unit makes it quick and easy to customise the height of the toilet support for different users and different needs.

3.4 Suitable operator

The intended operator can include anyone who has read and understood this manual. However, children are excluded.

3.5 Product dimensions

40-40450 – Height adjustable unit with quick release

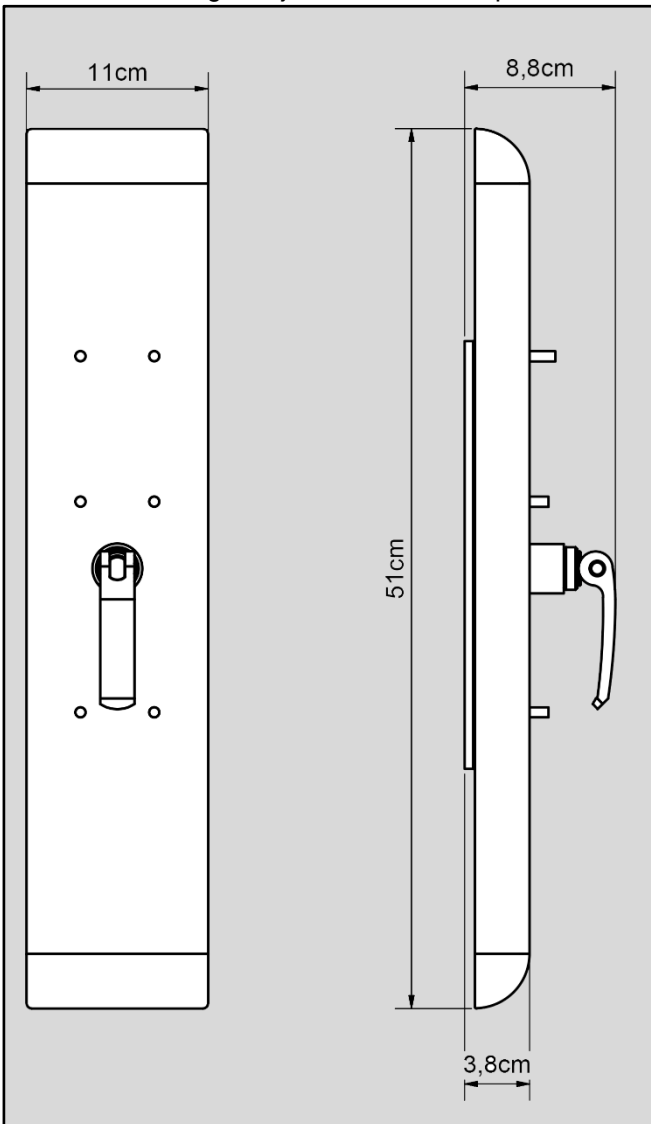

40-40451 – Height adjustable – requires tools

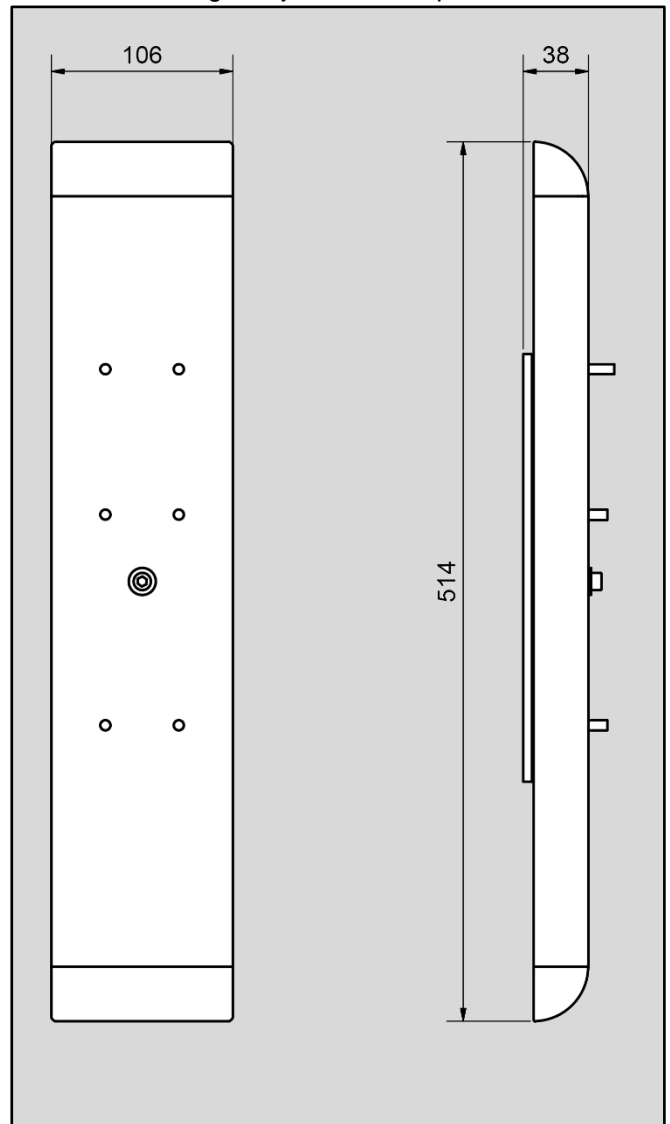

4. Instructions for use

4.1 Mounting interfaces

Construction

The wall must be made of screw-retaining material approved for wet rooms. The shaded area indicates the minimum area for wall reinforcement. Reinforcement is best installed from floor to ceiling. It is important that there is room for the plate cover to move 100 mm up and down.

The height adjustable unit is load tested according to DS/ISO 17966 and the maximum user weight is set to:

Max. user weight according to DS/ISO 17966
250 kg

Max. torque top screws
125 kg

Location of top holes

Location depends on which toilet support is used. All measurements are in mm and based on a fixed height to the top of the toilet support of 800 mm +/- 100 mm above floor. If this measurement is to be changed, the recommended measurements must be changed accordingly.

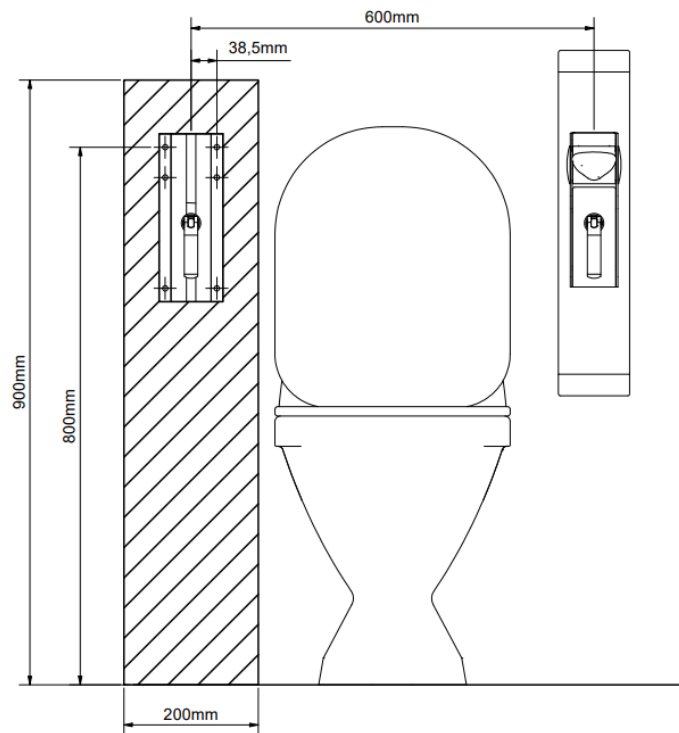

The unit comes with a set (6 pcs) of screws and wall plugs that are intended for mounting on a concrete wall. The installer must always assess the material, nature and strength of the wall and use suitable screws and wall plugs for that particular type of wall.

4.2 Installing the product

1. Drill holes according to the desired height and width of the toilet supports (see section on mounting interfaces)
2. Screw the wall plate to the wall, making sure it is straight horizontally and vertically

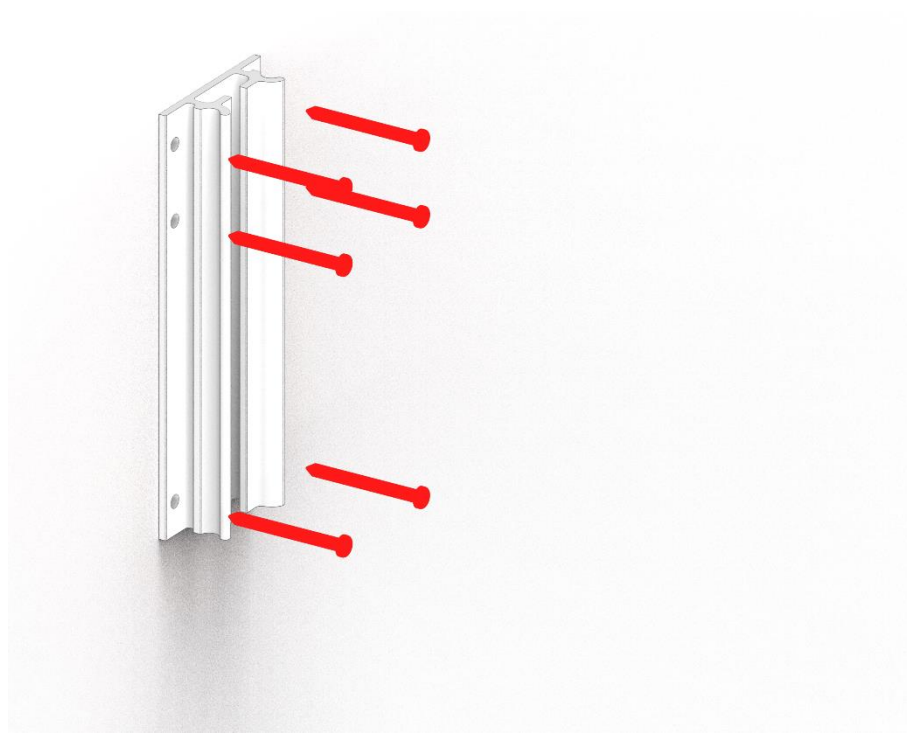

- 3. Mount the faceplate from above in the wall bracket.

Make sure that the clamping handle is loosened and that the locking piece connected to it is aligned to fit in the slot on the wall bracket.

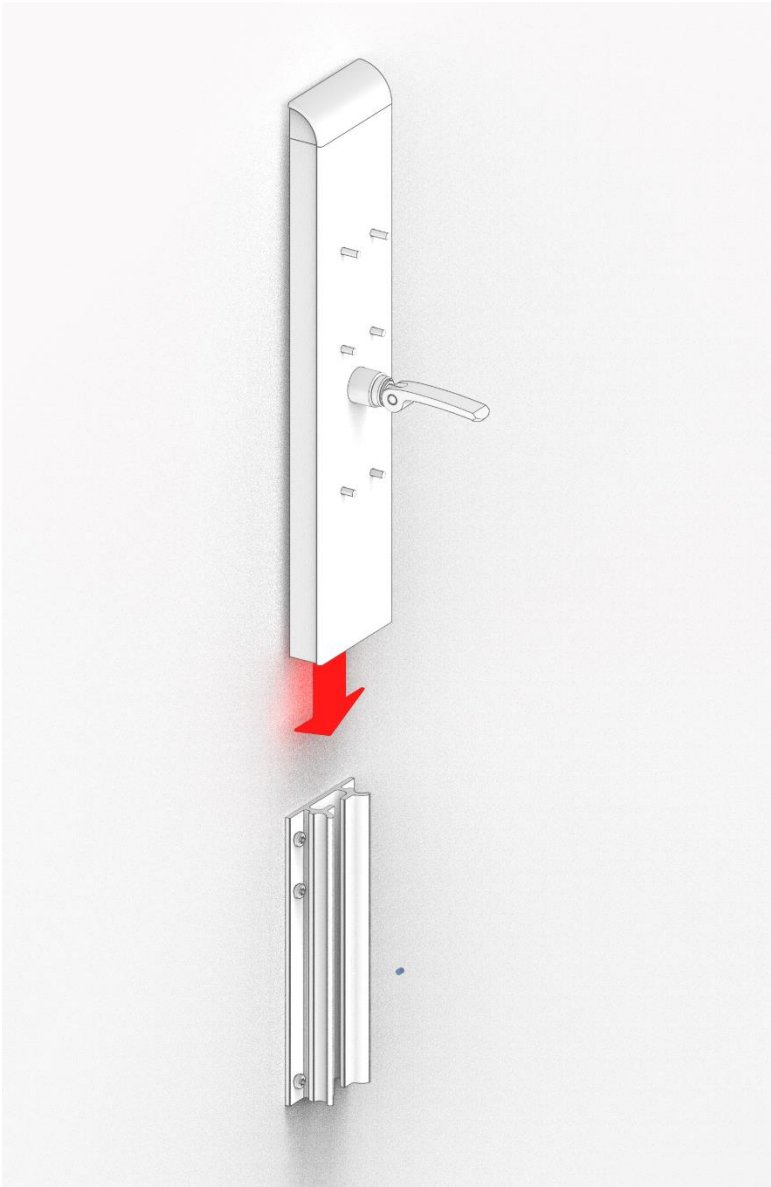
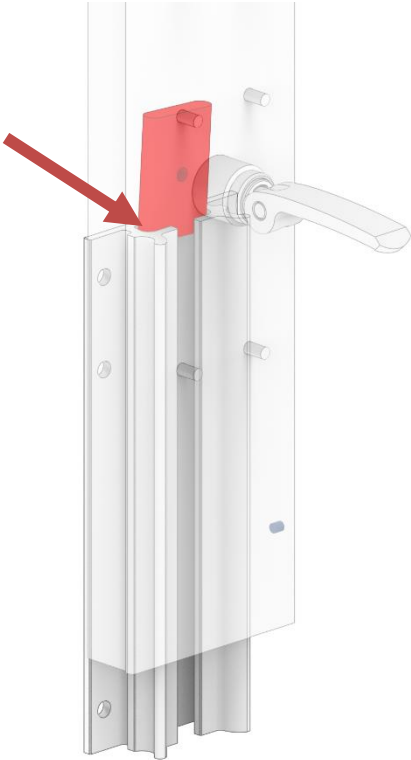

4. Mount the locking plate with the two screws at the bottom of the front bracket
5. Click the bottom cover plate on



4.3 Installation of toilet support

1. Find the 6 lock nuts supplied



2. Loosen the clamping handle so that it points outwards and place the toilet support over the threaded rods and guide the clamping handle through the hole in the toilet support wall bracket



3. Screw the nuts tightly over the threaded rods. Take special care when installing the top two nuts as the screwdriver head can leave marks on the toilet seat drum



4. Slide the cover plate with cut-out over the clamping handle and click it into place
5. Install the upper cover plate
6. Test that the product can be adjusted from top to bottom without bumping into other fixed objects in the room



4.4 Operating the product – quick release

To adjust the height of the height-adjustable unit:

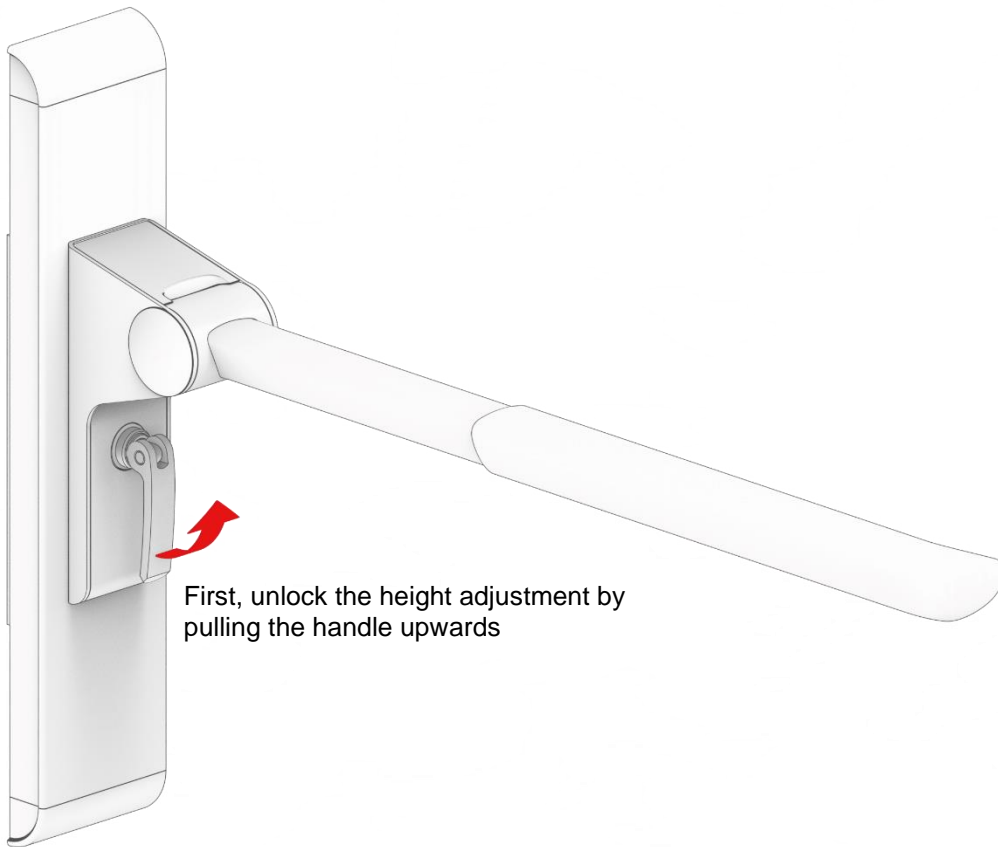

First, unlock the height adjustment by pulling the handle upwards

The toilet support can now be steplessly adjusted to the desired height.

To lock into position, press the handle downwards.

Height adjustment is infinitely adjustable within a range of 200 mm.

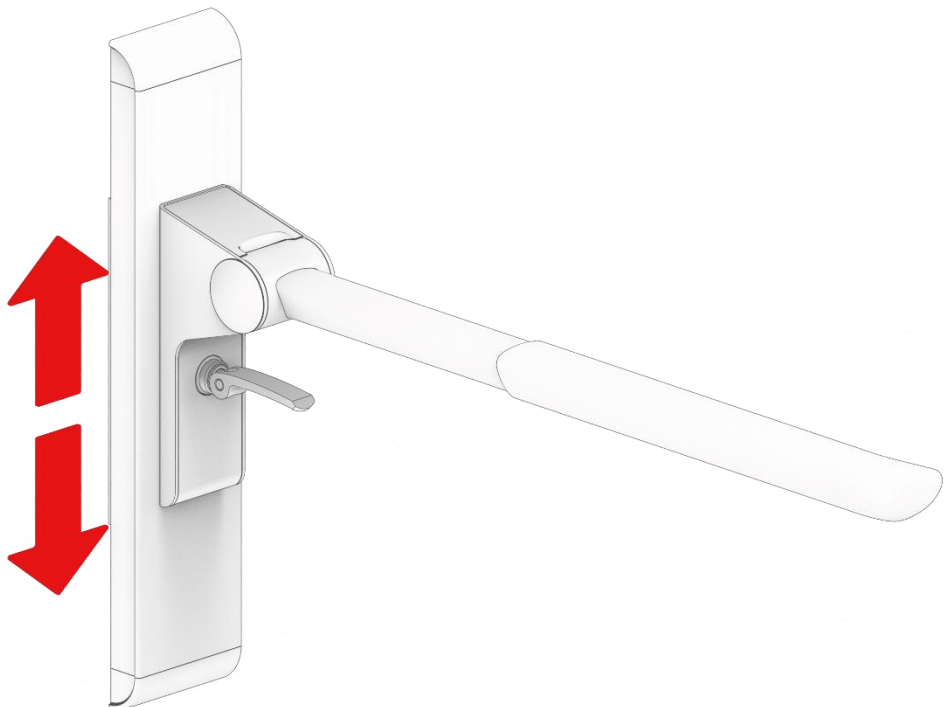

4.5 Operating the product – without quick release

To adjust the height of the height-adjustable device without quick release:



Remove the lower cover plate. A small flat screwdriver can be used in the slot on the underside



Use an Allen key to loosen the screw by turning it anti-clockwise one turn

The height adjustment is now freely adjustable. When the desired height is reached, tighten the screw again.

Always check that the height adjustment is safe and securely fastened before using the toilet support.

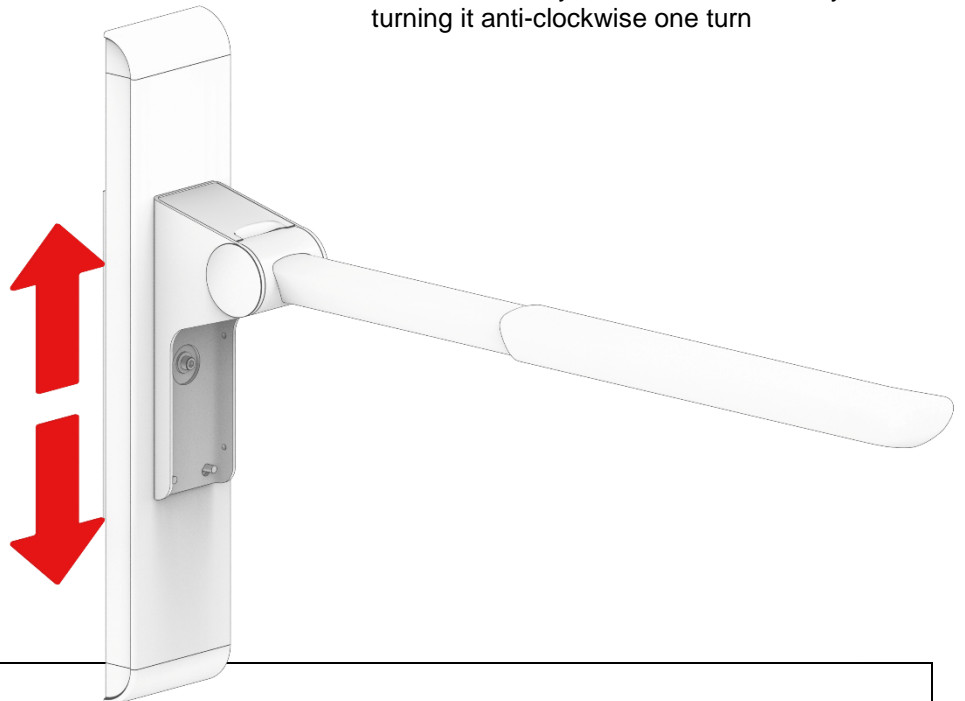

Warning!

Always position the product so that it can move freely through its intended arc without hitting anything. Failure to comply may result in loss of product stability.

5. Cleaning

Clean using lukewarm water and a suitable all-purpose cleaner. Use a cloth or soft sponge to wash the product. Wipe the product with a wrung-out cloth.

For surface disinfection, chlorine-based disinfectants can be used as long as product specifications and safety precautions are followed, but the concentration must not exceed 1,000 ppm active chlorine. Ethanol-based disinfectants can also be used as long as product specifications and safety precautions are followed.

The following products have been tested by Ropox and can be used as long as they are diluted according to the product instructions.

5.1 Pre-approved disinfectants

Trade name	Solution
Diversey Suma Tab D4	1,000 ppm
Rodalon ®	Ethanol 70% v/v

Immediately after cleaning or disinfection, wipe the product with a cloth soaked in water and then a dry towel, as failure to wipe the product may cause discolouration or staining and may damage the surface treatment. Please note that the product can be expected to lose some shine or colour after prolonged use with normal cleaning intervals. The product can be disinfected independent of cleaning.

	<p>Please note! Do not use cleaning agents that contain abrasive substances, e.g. scouring powder, steel wool, scouring pad.</p> <p>This product is not designed to be sterilised, autoclaving and sterilisation beyond normal cleaning may alter the safety and function of the product.</p>
--	--

6. Maintenance

The height-adjustable unit is maintenance-free. For safety reasons, we recommend regular inspection of all bolted connections and moving parts to ensure that no parts are loose and that fastenings to the wall are intact.

	<p>Please note! Failure to perform regular maintenance may result in degradation of the product's function and safety.</p>
---	---

7. Environmental considerations

The product is not intended for disposal as municipal waste. Proper disassembly, sorting and disposal of components must be performed by waste management.



Component	Disposal recommendation
Handle	Metal
Wall plate	Metal
Front plate	Metal
End caps	Residual waste

8. Accident/incident reporting

The manufacturer of this product recommends that any accident/incident related to this product that fulfils all of the criteria below should be reported to the relevant authority and to the manufacturer.

1. *An accident/incident has happened – or could have happened*
2. *The medical device is considered a contributing factor to the incident and*
3. *The accident resulted – or could have resulted – in one of the following consequences:*
 - *Death of a patient, user or third party*
 - *A serious deterioration in the patient's, user's or third party's health condition, including in the form of:*
 - *1. Life-threatening disease*
 - *2. Permanent injury or disability*
 - *3. Necessary medical or surgical treatment to prevent life-threatening illness, permanent injury or disability*
 - *4. Foetal death, birth defects or congenital abnormalities.*