

KITCHEN ORDER FORM



Date: _____ Requested delivery date: _____

User Reference: _____

Order No. _____ Customer: _____

Order

Quotation

Order No.: _____

Vendor: _____

User: _____

Name: _____

Address: _____

Postcode: _____ City: _____

Tel. (private): _____ Tel. (Work/Office): _____

E-mail: _____

Delivery/Installation Same as user

Postcode: _____ City: _____

Contact Person: _____

Telephone: _____ Mobile: _____

E-Mail: _____

Clarifying points Yes No

Is Installation schedule agreed?

Other products to be installed at the same time?

Attention! Any changes that affect ropox should be notified immediately

KITCHEN ORDER FORM

Sketch of the kitchen with dimensions and specifications of the height adjustable products

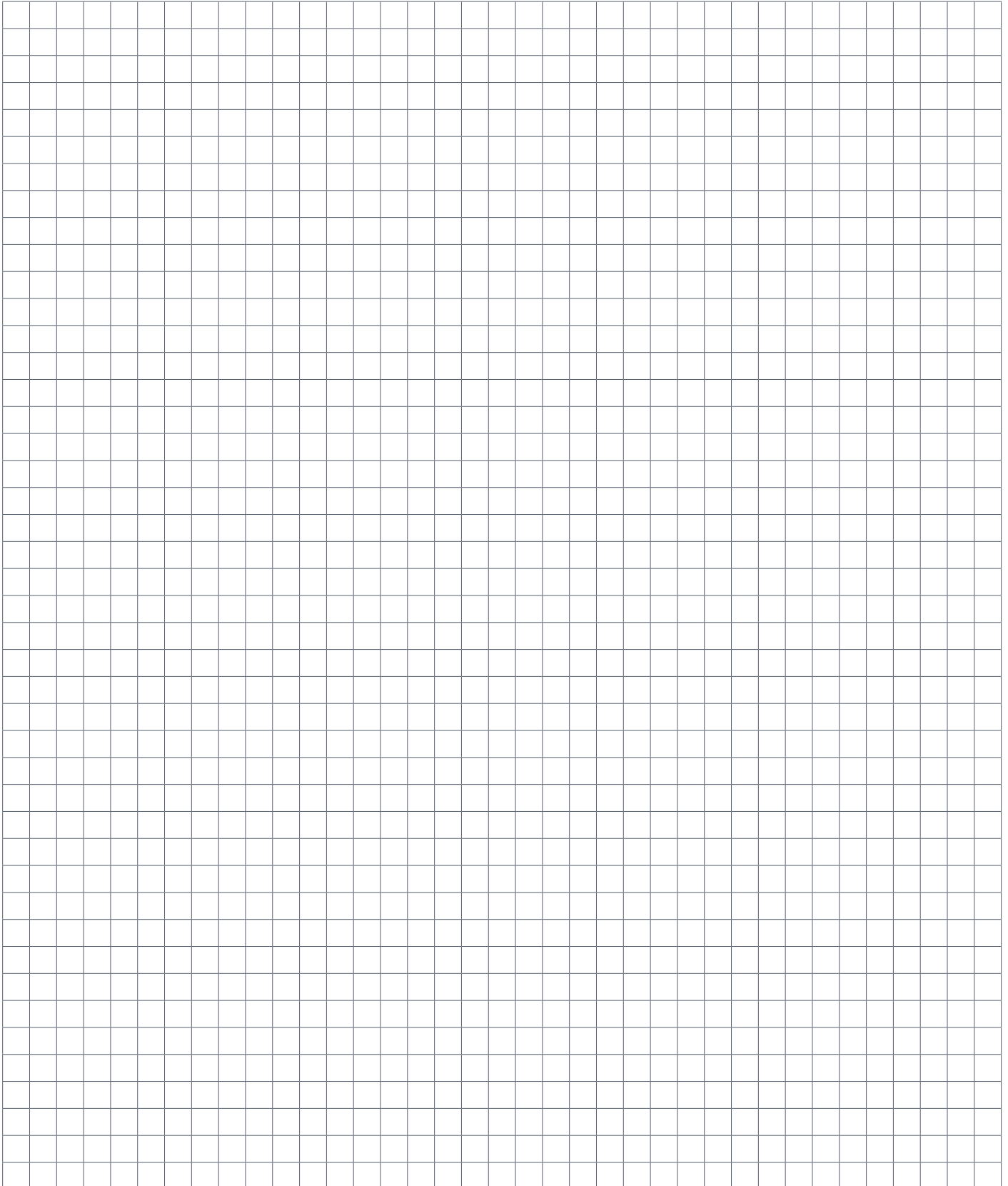
A large grid of graph paper, consisting of 30 columns and 40 rows of small squares, intended for sketching a kitchen layout. The grid is empty and occupies the majority of the page below the instruction.

KITCHEN ORDER FORM

Sketch of the kitchen with dimensions and specifications of the height adjustable products

A large grid of graph paper, consisting of 30 columns and 40 rows of small squares, intended for sketching a kitchen layout. The grid is empty and occupies the majority of the page below the instruction.

KITCHEN ORDER FORM

TIPS AND TRICKS BEFORE DESIGN AND PURCHASE



1. **Recommended distance between / space next to sink and hob**
- 80cm
2. **Household appliances - type and location:**
- High location of oven, dishwasher and fridge for wheelchair users
3. **Selection of the raising and lowering unit for cabinets and free space in connection with the height adjustment:**

	DIAGONAL	VERTIELECTRIC	VERTIINSIDE	FLEXIELECTRIC/ MANUAL	4SINGLE EL/MAN
WIDTH	40-180 cm	40-180 cm	40-100 cm	60-300 cm	60x60 - 200x300 cm
ADJUSTMENT	Vertical 42cm, Forwards-18cm	Range 30cm	Range 49,5cm	Range 65-95cm, without worktop	Range 65-95cm, or 55-85cm without worktop
USER TYPE	Wheelchair, Limited Reach	Walker, Office chair Standing	Wheelchair, Standing	Wheelchair, Walker, Office chair, Standing	Wheelchair, Walker, Office chair, Standing
INSTALLATION OF FRAME	Behind the wall unit (+11.5±0.3cm)	Behind the wall unit (+5±0.1cm)	Inside the wall unit	Underneath the worktop	Underneath the worktop
LIMITATIONS	Not above the Hob	Not above the Hob, Sink or Tap	Not above the Hob, Sink or Tap		
PLACEMENT OF OTHER OBJECTS (KETTLE, TOASTER ETC.)	At the very back of the table top	At the very front of the table top	At the very front of the table top	Depending on the upper cabinet No placement under the table top	Depending on the upper cabinet No placement under the table top

KITCHEN ORDER FORM

4. Otherwise

- We recommend that the sink has a maximum depth of 10cm for optimum accessibility for wheelchair users.
- To avoid the risk of scalding, the underside of the sink must be insulated.
- A drawer unit on wheels can be used for more storage space. Be aware of possible trapping risk when drawer cabinets are positioned under the table.
- Pull out plate under the oven offers a transfer shelf for a wheelchair user.
- Small wall unit doors (maximum 30 cm) offer best access to the wall unit in the lower position.
- 180 ° hinges in the wall unit doors offer good accessibility.

5. Trapping risk

- We always recommend the use of a Safety Stop (wall units) or Safety Strip (worktops) to prevent the risk of trapping when using electrical equipment.
- FlexiElectric – we recommend mounting the Safety Strip on all 3 sides of the worktop. Safety Strip is mounted underneath the fascia. When the frame moves down and the Safety Strip is activated, the frame stops and reverses by up to 2 cm.
- DiagonalElectric - mount the Safety Stop on the underside of the wall unit. When the frame moves down and the Safety Stop is activated, the wall unit frame stops and reverses by up to 2 cm.
- VertiElectric - mount the Safety Stop on the underside of the wall unit. When the frame moves down and the Safety stop is activated, the wall unit frame stops and reverses by up to 2 cm.
- VertiInside - Safety Stops on the underside and on the top of the wall unit are included in the order. When the frame moves down and the safety stop is activated, the wall unit frames stops and reverses by up to 2 cm.
If an item has been placed on the top shelf and the shelves are going up, the item will activate the top Safety stop and the movement stops and reverses by up to 2cm.
- 4SingleElectric - attach the Safety strip underneath the table fascias which are mounted on all four sides of the table. When the frame moves down and the safety strip is activated, the table stops and reverses by up to 2 cm.

6. Trapping risk when electrical operated units are adjacent to each other.

- Smartboxes interlink all the Safety Strips and Stops that could conflict with one another. They are needed when a wall unit frame is above a worktop frame or two (or more) worktop frames are next to each other.
- For every height adjustable unit in the group, a Smartbox is required.
- This way the Smartboxes will connect all the safety systems and survey the complete system to be able to stop any movement in case of a trapping.

7. Control buttons for Diagonal/VertiInside and VertiElectric are to be mounted on the front fascia of the Flexi worktop.

- We recommend a cable conductor inside the wall to be able to run the cable from the wall unit down underneath the worktop.

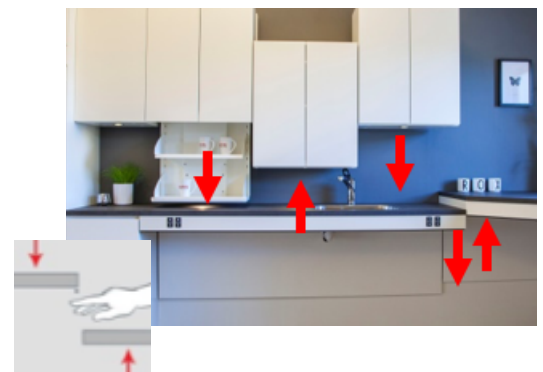

KITCHEN ORDER FORM

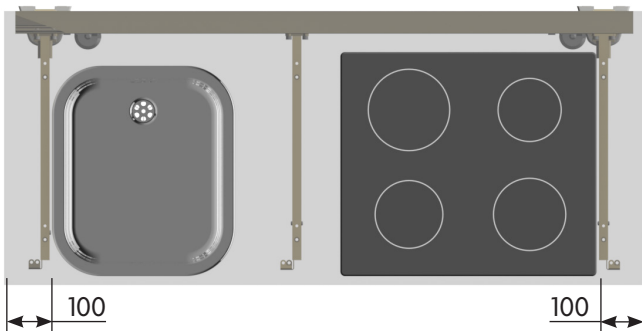
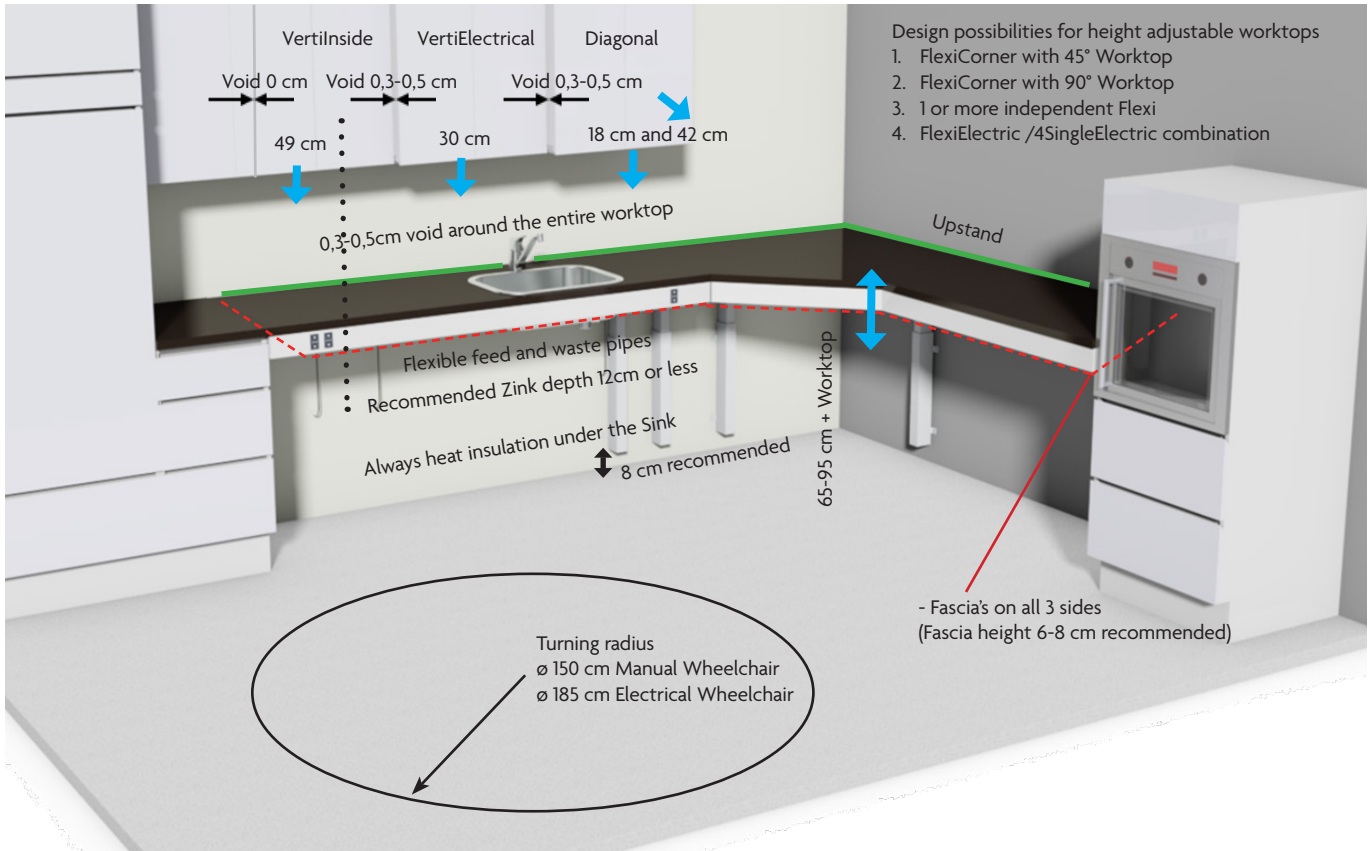

FlexiElectric & FlexiManual are delivered with this standard Arm Support:

See accessories for more options regarding different length.

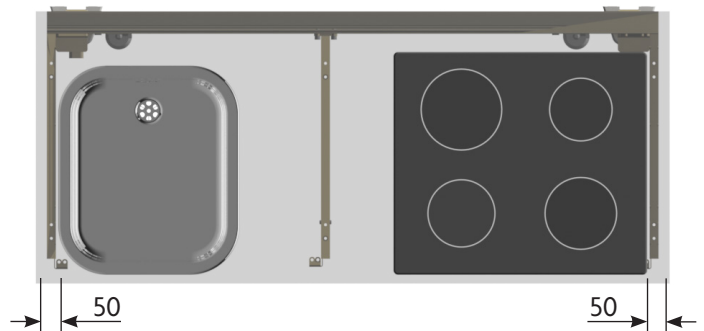

Special Right / Left Arm Supports can be ordered to allow more space for cutouts in the worktop:

See accessories for more options regarding these R/L special Arm Supports which also comes in different length.

KITCHEN ORDER FORM

ROPOX FLEXIELECTRIC

Electrical height adjustment frame for worktop length 30-300cm and depth 58-62cm. Height adjustment 30cm from 65-95cm + worktop thickness.

As standard the Flexi frame will be delivered 5 cm shorter than the worktop length, and depth 58-62cm.

For other worktop depths please refer to "Arm Support" under accessories, these will be delivered with no extra costs if ordered together on the same order.

The two length-dependent components, aluminum profile and hexagonal shaft, can be shortened on site if required. The sets are inclusive of control box and control button size 6x3cm

Safety Strip can be chosen (see safety accessories).

It is possible to reduce the height range of FlexiElectric in increments of 1cm, must be ordered with the overall order. (Accessory)
FlexiElectric comes with 2/3 pieces of flexible and self-adhesive cable carriers that can be mounted under the table top to ensure all cables are correctly secured.

Standard set Color: White RAL 9010

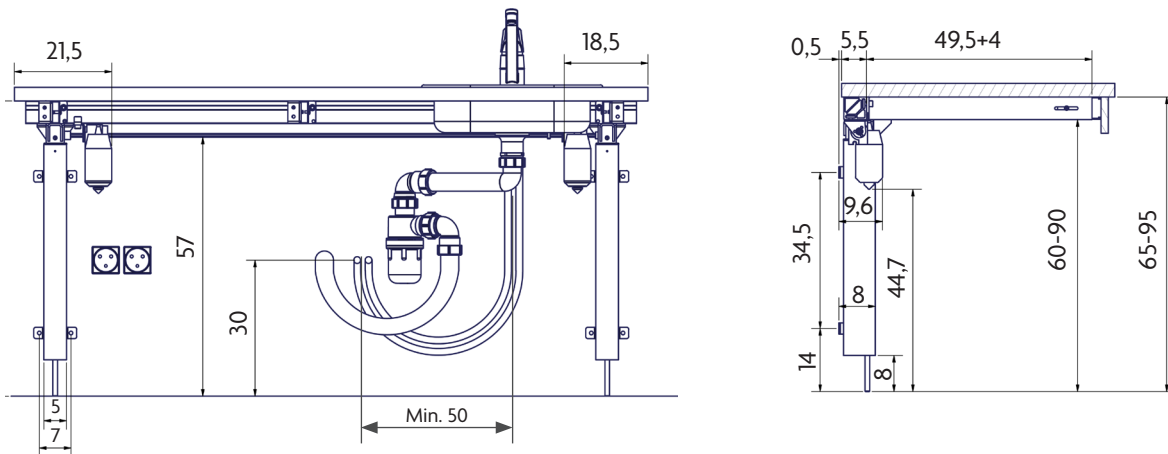

Detailed information's to be found in "Installations Manual"

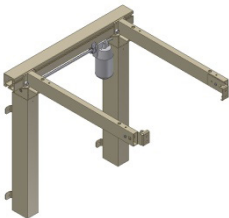

Alle Masse in cm

	FLEXIELECTRIC	PART NO.	PCS.
	<input type="checkbox"/> FlexiElectric for Worktop L=60cm	30-66060	
	<input type="checkbox"/> FlexiElectric for Worktop L=65cm	30-66065	
	<input type="checkbox"/> FlexiElectric for Worktop L=70cm	30-66070	
	<input type="checkbox"/> FlexiElectric for Worktop L=75cm	30-66075	
	<input type="checkbox"/> FlexiElectric for Worktop L=80cm	30-66080	
	<input type="checkbox"/> FlexiElectric for Worktop L=85cm	30-66085	
	<input type="checkbox"/> FlexiElectric for Worktop L=90cm	30-66090	
	<input type="checkbox"/> FlexiElectric for Worktop L=95cm	30-66095	
	<input type="checkbox"/> FlexiElectric for Worktop L=100cm	30-66100	

KITCHEN ORDER FORM

	<input type="checkbox"/> FlexiElectric for Worktop L=105cm	30-66105		
	<input type="checkbox"/> FlexiElectric for Worktop L=110cm	30-66110		
	<input type="checkbox"/> FlexiElectric for Worktop L=115cm	30-66115		
	<input type="checkbox"/> FlexiElectric for Worktop L=120cm	30-66120		
	<input type="checkbox"/> FlexiElectric for Worktop L=125cm	30-66125		
	<input type="checkbox"/> FlexiElectric for Worktop L=130cm	30-66130		
	<input type="checkbox"/> FlexiElectric for Worktop L=135cm	30-66135		
	<input type="checkbox"/> FlexiElectric for Worktop L=140cm	30-66140		
	<input type="checkbox"/> FlexiElectric for Worktop L=145cm	30-66145		
	<input type="checkbox"/> FlexiElectric for Worktop L=150cm	30-66150		
	<input type="checkbox"/> FlexiElectric for Worktop L=155cm	30-66155		
	<input type="checkbox"/> FlexiElectric for Worktop L=160cm	30-66160		
	<input type="checkbox"/> FlexiElectric for Worktop L=165cm	30-66165		
	<input type="checkbox"/> FlexiElectric for Worktop L=170cm	30-66170		
	<input type="checkbox"/> FlexiElectric for Worktop L=175cm	30-66175		
	<input type="checkbox"/> FlexiElectric for Worktop L=180cm	30-66180		
	<input type="checkbox"/> FlexiElectric for Worktop L=185cm	30-66185		
	<input type="checkbox"/> FlexiElectric for Worktop L=190cm	30-66190		
	<input type="checkbox"/> FlexiElectric for Worktop L=195cm	30-66195		
<input type="checkbox"/> FlexiElectric for Worktop L=200cm	30-66200			
	<input type="checkbox"/> FlexiElectric for Worktop L=205cm	30-66205		
	<input type="checkbox"/> FlexiElectric for Worktop L=210cm	30-66210		
	<input type="checkbox"/> FlexiElectric for Worktop L=215cm	30-66215		
	<input type="checkbox"/> FlexiElectric for Worktop L=220cm	30-66220		
	<input type="checkbox"/> FlexiElectric for Worktop L=225cm	30-66225		
	<input type="checkbox"/> FlexiElectric for Worktop L=230cm	30-66230		
	<input type="checkbox"/> FlexiElectric for Worktop L=235cm	30-66235		
	<input type="checkbox"/> FlexiElectric for Worktop L=240cm	30-66240		
	<input type="checkbox"/> FlexiElectric for Worktop L=245cm	30-66245		
	<input type="checkbox"/> FlexiElectric for Worktop L=250cm	30-66250		
	<input type="checkbox"/> FlexiElectric for Worktop L=255cm	30-66255		
	<input type="checkbox"/> FlexiElectric for Worktop L=260cm	30-66260		
	<input type="checkbox"/> FlexiElectric for Worktop L=265cm	30-66265		
	<input type="checkbox"/> FlexiElectric for Worktop L=270cm	30-66270		
	<input type="checkbox"/> FlexiElectric for Worktop L=275cm	30-66275		
	<input type="checkbox"/> FlexiElectric for Worktop L=280cm	30-66280		
	<input type="checkbox"/> FlexiElectric for Worktop L=285cm	30-66285		
	<input type="checkbox"/> FlexiElectric for Worktop L=290cm	30-66290		
	<input type="checkbox"/> FlexiElectric for Worktop L=295cm	30-66295		
	<input type="checkbox"/> FlexiElectric for Worktop L=300cm	30-66300		

KITCHEN ORDER FORM

ROPOX FLEXIELECTRIC CORNER

Electrical height adjustment frame for Corner worktop length 90–300 x 90-300cm and depth 58-62cm. Height adjustment 30cm from 65-95cm + worktop thickness.

As standard the FlexiElectricCorner frame will be delivered 5 cm shorter than the worktop length, and depth 58-62cm.

For other worktop depths please refer to “Arm Support” under accessories, these will be delivered with no extra costs if ordered together on same order.

The two length-dependent components, aluminum profile and hexagonal shaft, can be shortened on site if required. The sets are inclusive of control box and control button size 6x3cm. Safety Strip can be chosen (see safety accessories).

It is possible to reduce the height range of FlexiElectricCorner in increments of 1cm, must be ordered with the overall order. (Accessory). FlexiElectric comes with 2/3 pieces of flexible and self-adhesive cable carriers that can be mounted under the table top to ensure all cables are correctly secured. Standard set Color: White RAL 9010

Detailed information's to be found in “Installations Manual”



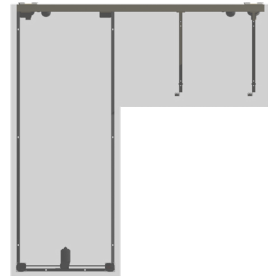
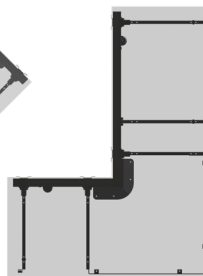
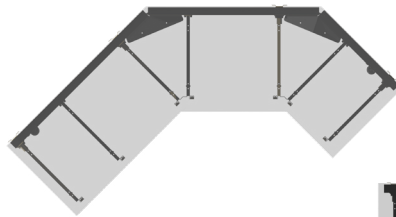
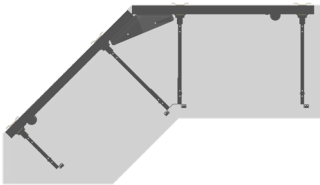

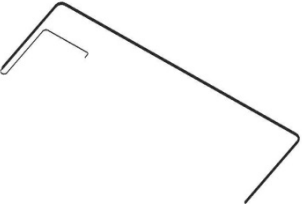

	FLEXIELECTRIC CORNER	PART NO.			PCS.
	<input type="checkbox"/> FlexiElectricCorner 90-150 x 90-300 cm	30-50020			
	<input type="checkbox"/> FlexiElectricCorner 155-300 x 155-300 cm	30-50021			
	Please state length of worktop L1 & L2 including the depth	L1	L2	Depth	





Inspiration for alternative solutions for FlexiElectricCorner Models, Please contact Ropox for further details.

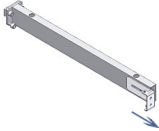



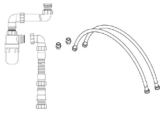

	ACCESSORIES FOR FLEXIELECTRIC, FLEXIELECTRIC-CORNER & 4SINGLEELECTRIC	PART NO.		PCS.
	<input type="checkbox"/> Safety strip, L=56 cm + 150 cm cable	30-69056		
	<input type="checkbox"/> Safety strip, L=120 cm + 150 cm cable	30-69120		
	<input type="checkbox"/> Safety strip, L=160 cm + 150 cm cable	30-69160		
	<input type="checkbox"/> Safety strip, L=200 cm + 150 cm cable	30-69200		
	<input type="checkbox"/> Safety strip, L=240 cm + 150 cm cable	30-69240		
	<input type="checkbox"/> Safety strip, L=270 cm + 150 cm cable	30-69270		
	<input type="checkbox"/> Safety strip, L=280 cm + 150 cm cable	30-69280		
	<input type="checkbox"/> Safety strip, L=320 cm + 150 cm cable	30-69320		
	<input type="checkbox"/> Safety strip, L=420 cm + 150 cm cable	30-69420		
	<input type="checkbox"/> Safety strip, L=520 cm + 150 cm cable	30-69520		
	<input type="checkbox"/> Safety strip, L=620 cm + 150 cm cable	30-69620		
	<input type="checkbox"/> Safety strip, L=820 cm + 150 cm cable	30-69820		
	<input type="checkbox"/> Safety strip, L=920 cm + 150 cm cable	30-69920		
	<input type="checkbox"/> Re-programming of control unit reduces the standard height range (30cm) in increments of 1 cm. Without any extra costs if ordered with the frame.	30-66010		

KITCHEN ORDER FORM

	ACCESSORIES FOR FLEXIELECTRIC & FLEXIMANUAL	PART NO.		PCS.
	<input type="checkbox"/> Cover, telescopic for standard Flexi Leg. White	30-67735		
	<input type="checkbox"/> Cover, telescopic for standard Flexi Leg when Supporting foot is used. White	30-67737		
	<input type="checkbox"/> Cover for Plumbing, can be used on Flexiframes L=120 to 300cm). Positioning of plumbing important, see Installation Manual for more info	30-67635		
	<input type="checkbox"/> Fittings for concealment panels (2 pcs.) Concealment panels not included	30-67760		
	<input type="checkbox"/> Supporting foot for Flexiframes L=30 cm	30-67702		
	<input type="checkbox"/> Supporting foot for Flexiframes L=49 cm	30-67703		
	<input type="checkbox"/> Distance bracket, allows 7cm free passage behind Flexilegs 1 pcs. =(2 Pieces needed per leg)	30-67672		
	<input type="checkbox"/> Arm support, Length 34,5cm. Worktop depth 43-47cm	30-67619		
	<input type="checkbox"/> Arm support, Length 59,5cm. Worktop depth 68-72cm	30-67621		
	<input type="checkbox"/> Arm support, Length 39,5cm. Worktop depth 48-52cm	30-67622		
	<input type="checkbox"/> Arm support, Length 29,5cm. Worktop depth 38-42cm	30-67623		
	<input type="checkbox"/> Arm support, Length 47cm. Worktop depth 56-60cm	30-67624		
	<input type="checkbox"/> Arm support, Length 57,5cm. Worktop depth 66-70cm	30-67625		
	<input type="checkbox"/> Arm support, Length 53,5cm. Worktop depth 62-66cm	30-67627		
	<input type="checkbox"/> Arm support, Right, Length 49,5cm. For Worktop depth= 58-62cm	30-67642		
	<input type="checkbox"/> Arm support, Left., Length 49,5cm For Worktop depth= 58-62cm	30-67643		
	<input type="checkbox"/> Arm support, Right, Length 47cm For Worktop depth= 56-60cm	30-67644		
	<input type="checkbox"/> Arm support, Left, Length 47cm For Worktop depth= 56-60cm	30-67645		
	<input type="checkbox"/> Arm support, Right, Length 53,5cm For Worktop depth= 62-66cm	30-67646		
	<input type="checkbox"/> Arm support, Left, Length 53,5cm For Worktop depth= 68-72cm	30-67647		
	<input type="checkbox"/> Arm support, Right, Length 59,5cm For Worktop depth= 68-72cm	30-67648		
	<input type="checkbox"/> Arm support, Left, Length 59,5cm For Worktop depth= 68-72cm	30-67649		

KITCHEN ORDER FORM

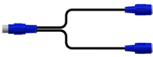
	<input type="checkbox"/> Plumbing kit, complete, white for kitchen	30-45010		
	<input type="checkbox"/> Sink A-400 40x34x13,5 cm (Including insulation pad)	30-45007		
	<input type="checkbox"/> Sink A-400 Handicap 40x34x10 cm (Including insulation pad)	30-45008		

	ACCESSORIES FLEXIELECTRIC, DIAGONAL, VERTI ELECTRIC, VERTIINSIDE & 4SINGLEELECTRIC	PART NO.		PCS.
	<input type="checkbox"/> Smartbox for connecting safety systems (1 per interconnecting frame)	30-69002		
	<input type="checkbox"/> Press pad 14x7cm 7 pins DIN plug, For Flexi and Diagonal (from Type -7)	30-67841		
	<input type="checkbox"/> Hand control incl. Spiral cord	40-14701		
	<input type="checkbox"/> Extension cable 250 cm, for safetystop	30-67870		
	<input type="checkbox"/> Spiral extension for safetystop	30-67871		
	<input type="checkbox"/> Extension cable for standard control Switch and press pad for VertiElectric	30-40660		
	<input type="checkbox"/> Extension cable for Diagonal control Switch, L=3,5m incl spiral cord for Diagonal & VertiInside	93000164		
	<input type="checkbox"/> Y cable, if you want 2x control buttons	96000629		
	<input type="checkbox"/> Control button	30-67840		

KITCHEN ORDER FORM

ROPOX FLEXIMANUAL

Manual height adjustment frame for worktop length 30-300cm and depth 58-62cm. Height adjustment 30cm from 65-95cm + worktop thickness.

As standard the Flexi frame will be delivered 5 cm shorter than the worktop length, and depth 58-62cm.

For other worktop depths please refer to "Arm Support" under accessories, these will be delivered with no extra costs if ordered together on same order.

The two length-dependent components, aluminum profile and hexagonal shaft, can be shortened on site if required.

Standard set Color: White RAL 9010

Detailed information can be found in "Installations Manual"

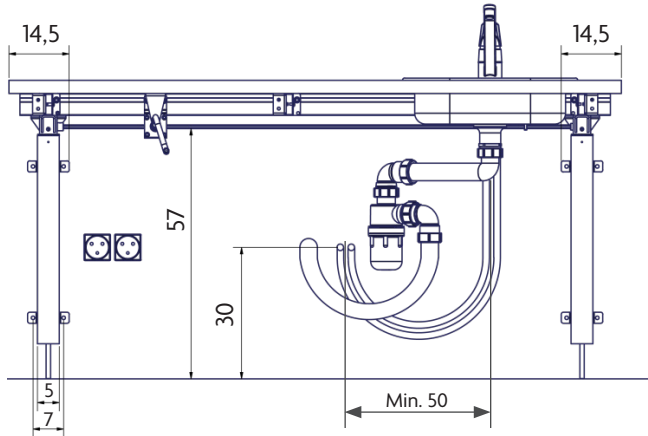

All measurements in cm

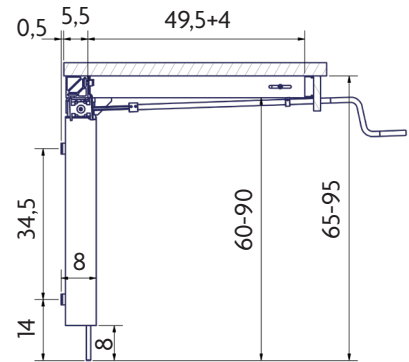

	FLEXIMANUAL	PART NO.	PCS.
	<input type="checkbox"/> FlexiManual for Worktop L=60cm	30-65060	
	<input type="checkbox"/> FlexiManual for Worktop L=65cm	30-65065	
	<input type="checkbox"/> FlexiManual for Worktop L=70cm	30-65070	
	<input type="checkbox"/> FlexiManual for Worktop L=75cm	30-65075	
	<input type="checkbox"/> FlexiManual for Worktop L=80cm	30-65080	
	<input type="checkbox"/> FlexiManual for Worktop L=85cm	30-65085	
	<input type="checkbox"/> FlexiManual for Worktop L=90cm	30-65090	
	<input type="checkbox"/> FlexiManual for Worktop L=95cm	30-65095	
	<input type="checkbox"/> FlexiManual for Worktop L=100cm	30-65100	
	<input type="checkbox"/> FlexiManual for Worktop L=105cm	30-65105	
	<input type="checkbox"/> FlexiManual for Worktop L=110cm	30-65110	
	<input type="checkbox"/> FlexiManual for Worktop L=115cm	30-65115	
	<input type="checkbox"/> FlexiManual for Worktop L=120cm	30-65120	
	<input type="checkbox"/> FlexiManual for Worktop L=125cm	30-65125	
	<input type="checkbox"/> FlexiManual for Worktop L=130cm	30-65130	
	<input type="checkbox"/> FlexiManual for Worktop L=135cm	30-65135	
	<input type="checkbox"/> FlexiManual for Worktop L=140cm	30-65140	
	<input type="checkbox"/> FlexiManual for Worktop L=145cm	30-65145	
	<input type="checkbox"/> FlexiManual for Worktop L=150cm	30-65150	
	<input type="checkbox"/> FlexiManual for Worktop L=155cm	30-65155	
	<input type="checkbox"/> FlexiManual for Worktop L=160cm	30-65160	
	<input type="checkbox"/> FlexiManual for Worktop L=165cm	30-65165	

KITCHEN ORDER FORM

	<input type="checkbox"/> FlexiManual for Worktop L=170cm	30-65170		
	<input type="checkbox"/> FlexiManual for Worktop L=175cm	30-65175		
	<input type="checkbox"/> FlexiManual for Worktop L=180cm	30-65180		
	<input type="checkbox"/> FlexiManual for Worktop L=185cm	30-65185		
	<input type="checkbox"/> FlexiManual for Worktop L=190cm	30-65190		
	<input type="checkbox"/> FlexiManual for Worktop L=195cm	30-65195		
	<input type="checkbox"/> FlexiManual for Worktop L=200cm	30-65200		
	<input type="checkbox"/> FlexiManual for Worktop L=205cm	30-65205		
	<input type="checkbox"/> FlexiManual for Worktop L=210cm	30-65210		
	<input type="checkbox"/> FlexiManual for Worktop L=215cm	30-65215		
	<input type="checkbox"/> FlexiManual for Worktop L=220cm	30-65220		
	<input type="checkbox"/> FlexiManual for Worktop L=225cm	30-65225		
	<input type="checkbox"/> FlexiManual for Worktop L=230cm	30-65230		
	<input type="checkbox"/> FlexiManual for Worktop L=235cm	30-65235		
	<input type="checkbox"/> FlexiManual for Worktop L=240cm	30-65240		
	<input type="checkbox"/> FlexiManual for Worktop L=255cm	30-65255		
	<input type="checkbox"/> FlexiManual for Worktop L=260cm	30-65260		
	<input type="checkbox"/> FlexiManual for Worktop L=265cm	30-65265		
	<input type="checkbox"/> FlexiManual for Worktop L=270cm	30-65270		
	<input type="checkbox"/> FlexiManual for Worktop L=275cm	30-65275		
	<input type="checkbox"/> FlexiManual for Worktop L=280cm	30-65280		
	<input type="checkbox"/> FlexiManual for Worktop L=285cm	30-65285		
	<input type="checkbox"/> FlexiManual for Worktop L=290cm	30-65290		
	<input type="checkbox"/> FlexiManual for Worktop L=295cm	30-65295		
	<input type="checkbox"/> FlexiManual for Worktop L=300cm	30-65300		

ROPOX FLEXIMANUAL CORNER

Manual height adjustment frame for Corner worktop length 90x90 – 300x300cm and depth 58-62cm. Height adjustment 30cm from 65-95cm + worktop thickness.

As standard the Flexi frame will be delivered 5cm shorter than the worktop length, and depth 58-62cm.

For other worktop depths please refer to “Arm Support” under accessories, these will be delivered with no extra costs if ordered together on same order.

The two length-dependent components, aluminum profile and hexagonal shaft, can be shortened on site if required.

Standard set Color: White RAL 9010

Detailed information can be found in “Installations Manual”

	FLEXIMANUAL CORNER	PART NO.			PCS.
	<input type="checkbox"/> FlexiManualCorner 90-150 x 90-300cm	30-50010			
	<input type="checkbox"/> FlexiManualCorner 155-300 x 155-300cm	30-50011			
	Please state length of worktop L1 & L2 including the depth	L1	L2	Depth	

KITCHEN ORDER FORM

ROPOX DIAGONAL

Electrical height adjustment system for wall units. Height range 42cm and also 18cm forward. For wall unit widths of 40-180cm and height 70-92cm. Frame depth 11.5cm ±0.3cm. For cabinet heights of 55-68 cm you will need a special fitting for cabinets H=55-68cm. See the Accessory (order together with frame, at no extra cost). The sets are inclusive of control box and control buttons size 6x3cm. As an accessory, we always recommend the Safety Stop to prevent the risk of trapping for the downwards movement. These can also be ordered incl. LED light.

Control buttons should always be attached to the front edge of the Flexi fascia. If there is no fascia you may use a remote control (shown in the Flexi Accessories).

Standard set Colour: Chrome finish Surface, upper and lower rails in white RAL 9010

Detailed information can be found in the "Installation Manual"

  230V for Diagonal & 230V for LED Spot with separate switch

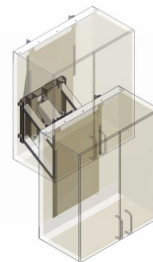
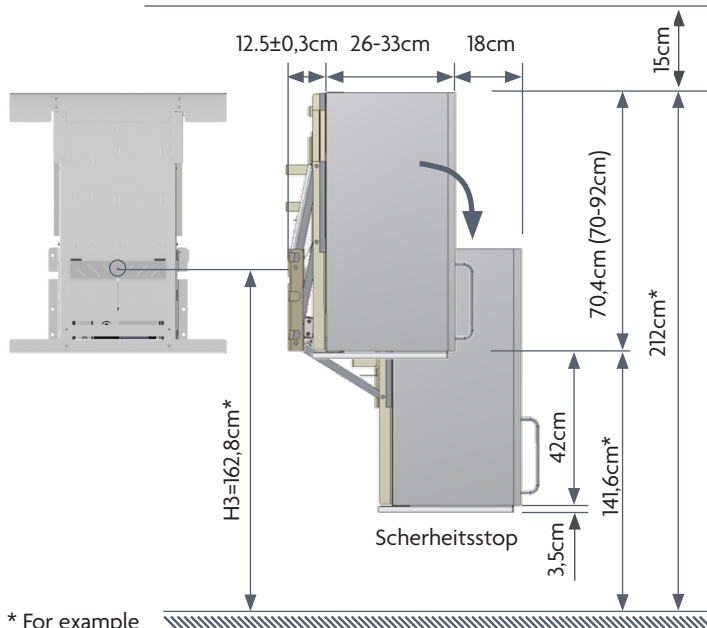

Height of the central fixing point (H3) is 21,2cm above the underside of the cabinet. Please keep in mind the minimum distance to the below worktop due to the height range of the Diagonal.

The maximum stroke $42+1+3.5\text{cm} = 46.5\text{cm}$ clear space needed to perform a reset!

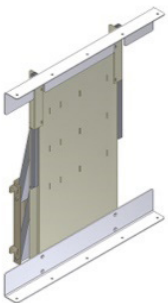
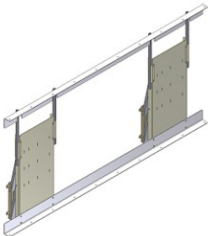

If you have ordered the LED spot in the Safety stop, be aware that an extra lamp output with a separate switch will be needed.

* For example

	DIAGONAL	PART NO.	PCS.
	<input type="checkbox"/> Diagonal, Cabinet width 40 cm	30-40904	
	<input type="checkbox"/> Diagonal, Cabinet width 50 cm	30-40905	
	<input type="checkbox"/> Diagonal, Cabinet width 60 cm	30-40906	
	<input type="checkbox"/> Diagonal, Cabinet width 70 cm	30-40907	
	<input type="checkbox"/> Diagonal, Cabinet width 80 cm	30-40908	
	<input type="checkbox"/> Diagonal, Cabinet width 90 cm	30-40909	
	<input type="checkbox"/> Diagonal, Cabinet width 100 cm	30-40910	
	<input type="checkbox"/> Diagonal, Cabinet width 110 cm	30-40911	
	<input type="checkbox"/> Diagonal, Cabinet width 120 cm	30-40912	
	<input type="checkbox"/> Diagonal, Cabinet width 130 cm	30-40913	
	<input type="checkbox"/> Diagonal, Cabinet width 140 cm	30-40914	
	<input type="checkbox"/> Diagonal, Cabinet width 150 cm	30-40915	
	<input type="checkbox"/> Diagonal, Cabinet width 160 cm	30-40916	
	<input type="checkbox"/> Diagonal, Cabinet width 170 cm	30-40917	
	<input type="checkbox"/> Diagonal, Cabinet width 180 cm	30-40918	

KITCHEN ORDER FORM

	ACCESSORIES FOR DIAGONAL & VERTIELECTRIC	PART NO.		PCS.
	<input type="checkbox"/> Safety stop, VertiElectric/Diagonal L=40cm	30-41604		
	<input type="checkbox"/> Safety stop, VertiElectric/Diagonal L=50cm	30-41605		
	<input type="checkbox"/> Safety stop, VertiElectric/Diagonal L=60cm	30-41606		
	<input type="checkbox"/> Safety stop, VertiElectric/Diagonal L=70cm	30-41607		
	<input type="checkbox"/> Safety stop, VertiElectric/Diagonal L=80cm	30-41608		
	<input type="checkbox"/> Safety stop, VertiElectric/Diagonal L=90cm	30-41609		
	<input type="checkbox"/> Safety stop, VertiElectric/Diagonal L=100cm	30-41610		
	<input type="checkbox"/> Safety stop, VertiElectric/Diagonal L=110cm	30-41611		
	<input type="checkbox"/> Safety stop, VertiElectric/Diagonal L=120cm	30-41612		
	<input type="checkbox"/> Safety stop, VertiElectric/Diagonal L=130cm	30-41613		
	<input type="checkbox"/> Safety stop, VertiElectric/Diagonal L=140cm	30-41614		
	<input type="checkbox"/> Safety stop, VertiElectric/Diagonal L=150cm	30-41615		
	<input type="checkbox"/> Safety stop, VertiElectric/Diagonal L=160cm	30-41616		
	<input type="checkbox"/> Safety stop, VertiElectric/Diagonal L=170cm	30-41617		
	<input type="checkbox"/> Safety stop, VertiElectric/Diagonal L=180cm	30-41618		

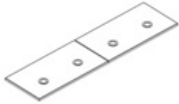
	SAFETY STOP WITH LED SPOT FOR DIAGONAL & VERTIELECTRIC	PART NO.		PCS.
	<input type="checkbox"/> Safety stop VertiElectric/Diagonal, L=40cm, 1 Stk. LED spot	30-42604		
	<input type="checkbox"/> Safety stop, VertiElectric/Diagonal L=50cm, 1 Stk. LED spot	30-42605		
	<input type="checkbox"/> Safety stop, VertiElectric/Diagonal L=60cm, 1 Stk. LED spot	30-42606		
	<input type="checkbox"/> Safety stop, VertiElectric/Diagonal L=70cm, 2 Stk. LED spots	30-42607		
	<input type="checkbox"/> Safety stop, VertiElectric/Diagonal L=80cm, 2 Stk. LED spots	30-42608		
	<input type="checkbox"/> Safety stop, VertiElectric/Diagonal L=90cm, 2 Stk. LED spots	30-42609		
	<input type="checkbox"/> Safety stop, VertiElectric/Diagonal L=100cm, 2 Stk. LEDspots	30-42610		
	<input type="checkbox"/> Safety stop, VertiElectric/Diagonal L=110cm, 2 Stk. LED spots	30-42611		
	<input type="checkbox"/> Safety stop, VertiElectric/Diagonal L=120cm, 2 Stk. LED spots	30-42612		
	<input type="checkbox"/> Safety stop, VertiElectric/Diagonal L=130cm, 3 Stk. LED spots	30-42613		
	<input type="checkbox"/> Safety stop, VertiElectric/Diagonal L=140cm, 4 Stk. LED spots	30-42614		
	<input type="checkbox"/> Safety stop, VertiElectric/Diagonal L=150cm, 4 Stk. LED spots	30-42615		
	<input type="checkbox"/> Safety stop, VertiElectric/Diagonal L=160cm, 4 Stk. LED spots	30-42616		
	<input type="checkbox"/> Safety stop, VertiElectric/Diagonal L=170cm, 4 Stk. LED spots	30-42617		
	<input type="checkbox"/> Safety stop, VertiElectric/Diagonal L=180cm, 4 Stk. LED spots	30-42618		

KITCHEN ORDER FORM

ROPOX VERTIINSIDE DEPTH 26,5CM

Electrical height adjustable shelf unit with a height range of 49.5cm. The Vertilnside comes in two different depths, 26.5cm or 31cm and for cabinet width 40 - 100cm. Vertilnside can be used for cabinets with a height of Minimum 70cm.

Vertilnside is delivered with control box and control button 6 x 3cm.

Safety Stops for the underside and for the top of the unit are included. LED spots for the safety stop must be ordered together with the unit.

Control buttons should always be attached to the front edge of the Flexi fascia. If there is no fascia you may use a remote control (shown in the Flexi Accessories). Standard set Color: White RAL 9010

Detailed information can be found in the "Installation Manual"

  230V for Vertilnside & 230V for LED Spot with separate switch

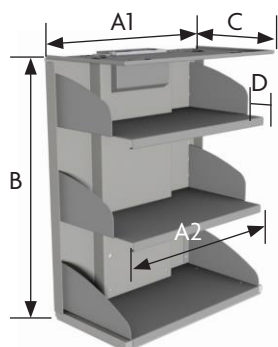

Installation dimensions for Vertilnside depth 26.5, all dimensions in cm .:



Cabinet outside width	40,0	50,0	60,0	70,0	80,0	90,0	100,0
A1=Vertilnside width	34,8	44,8	54,8	64,8	74,8	84,8	94,8
A2=Shelf width	30,8	40,8	50,8	60,8	70,8	80,8	90,8
B=Vertilnside Height	71,8	Incl. Safety stop					
C=Vertilnside Depth	26,5						
D	6,3						

If you have ordered the LED spot in the Safety stop, be aware that an extra lamp output with a separate switch will be needed.

	VERTIINSIDE, CABINET DEPTH 26.5CM	PART NO.	PCS.
	<input type="checkbox"/> Vertilnside, Cabinet width 40 cm	30-40404	
	<input type="checkbox"/> Vertilnside, Cabinet width 50 cm	30-40405	
	<input type="checkbox"/> Vertilnside, Cabinet width 60 cm	30-40406	
	<input type="checkbox"/> Vertilnside, Cabinet width 70 cm	30-40407	
	<input type="checkbox"/> Vertilnside, Cabinet width 80 cm	30-40408	
	<input type="checkbox"/> Vertilnside, Cabinet width 90 cm	30-40409	
	<input type="checkbox"/> Vertilnside, Cabinet width 100 cm	30-40410	

	ACCESSORIES FOR VERTIINSIDE, CABINET DEPTH 26.5CM	PART NO.	PCS.
	<input type="checkbox"/> LED spot for Vertilnside, Cabinet width 40 cm, 1 Pc.	30-40444	
	<input type="checkbox"/> LED spot for Vertilnside, Cabinet width 50 cm, 1 Pc.	30-40445	
	<input type="checkbox"/> LED spot for Vertilnside, Cabinet width 60 cm, 1 Pc.	30-40446	
	<input type="checkbox"/> LED spot for Vertilnside, Cabinet width 70 cm, 2 Pcs.	30-40447	
	<input type="checkbox"/> LED spot for Vertilnside, Cabinet width 80 cm, 2 Pcs.	30-40448	
	<input type="checkbox"/> LED spot for Vertilnside, Cabinet width 90 cm, 2 Pcs.	30-40449	
	<input type="checkbox"/> LED spot for Vertilnside, Cabinet width 100 cm, 2 Pcs.	30-40450	

KITCHEN ORDER FORM

ROPOX VERTIINSIDE DEPTH 31 CM

Electrical height adjustable shelf unit with a height range of 49.5cm. The Vertilnside comes in two different depths, 26.5cm or 31cm and for cabinet width 40 - 100cm. Vertilnside can be used for cabinets with a height of Minimum 70cm.

Vertilnside is delivered with control box and control button 6 x 3cm.

Safety Stops for the underside and for the top of the unit are included. LED spots for the safety stop must be ordered together with the unit.

Control buttons should always be attached to the front edge of the Flexi fascia. If there is no fascia you may use a remote control (shown in the Flexi Accessories). Standard set Color: White RAL 9010

Detailed information can be found in the "Installation Manual"

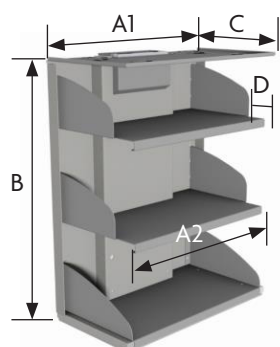

230V for Vertilnside & 230V for LED Spot with separate switch

Cabinet outside width	40,0	50,0	60,0	70,0	80,0	90,0	100,0
A1= Vertilnside Width	34,8	44,8	54,8	64,8	74,8	84,8	94,8
A2= Shelf Width	30,8	40,8	50,8	60,8	70,8	80,8	90,8
B= Vertilnside Height	71,8	Incl. Safety stop					
C= Vertilnside Depth	31,0						

D 6,3 If you have ordered the LED spot in the Safety stop, be aware that an extra lamp output with a separate switch will be needed.

	VERTIINSIDE, CABINET DEPTH 31CM	PART NO.	PCS.
	<input type="checkbox"/> Vertilnside, Cabinet width 40 cm	30-40414	
	<input type="checkbox"/> Vertilnside, Cabinet width 50 cm	30-40415	
	<input type="checkbox"/> Vertilnside, Cabinet width 60 cm	30-40416	
	<input type="checkbox"/> Vertilnside, Cabinet width 70 cm	30-40417	
	<input type="checkbox"/> Vertilnside, Cabinet width 80 cm	30-40418	
	<input type="checkbox"/> Vertilnside, Cabinet width 90 cm	30-40419	
	<input type="checkbox"/> Vertilnside, Cabinet width 100 cm	30-40420	
	ACCESSORY FOR VERTIINSIDE, CABINET DEPTH 31CM	PART NO.	PCS.
	<input type="checkbox"/> LED spot for Vertilnside, Cabinet width 40 cm, 1 Pc.	30-40454	
	<input type="checkbox"/> LED spot for Vertilnside, Cabinet width 50 cm, 1 Pc.	30-40455	
	<input type="checkbox"/> LED spot for Vertilnside, Cabinet width 60 cm, 1 Pc.	30-40456	
	<input type="checkbox"/> LED spot for Vertilnside, Cabinet width 70 cm, 2 Pcs.	30-40457	
	<input type="checkbox"/> LED spot for Vertilnside, Cabinet width 80 cm, 2 Pcs.	30-40458	
	<input type="checkbox"/> LED spot for Vertilnside, Cabinet width 90 cm, 2 Pcs.	30-40459	
	<input type="checkbox"/> LED spot for Vertilnside, Cabinet width 100 cm, 2 Pcs.	30-40460	

KITCHEN ORDER FORM

ROPOX VERTIELECTRIC

Electric height adjustment system for wall units. Lifting height 30 cm. For upper Cabinet width 40-180cm and height 70-92cm. Frame depth 5cm ±0.1cm. Vertielectric cannot be used for cabinets less than 70 cm high

The sets are inclusive of control box and control buttons size 6x3cm. As an accessory, we always recommend the Safety Stop to prevent the risk of trapping for the downwards movement. These can also be ordered incl. LED light.

Control buttons should always be attached to the front edge of the Flexi fascia. If there is no fascia you may use a remote control (shown in the Flexi Accessories).

Standard set Color: Chrome finish Surface, upper and lower rails in white RAL 9010

Detailed information can be found in the "Installation Manual"

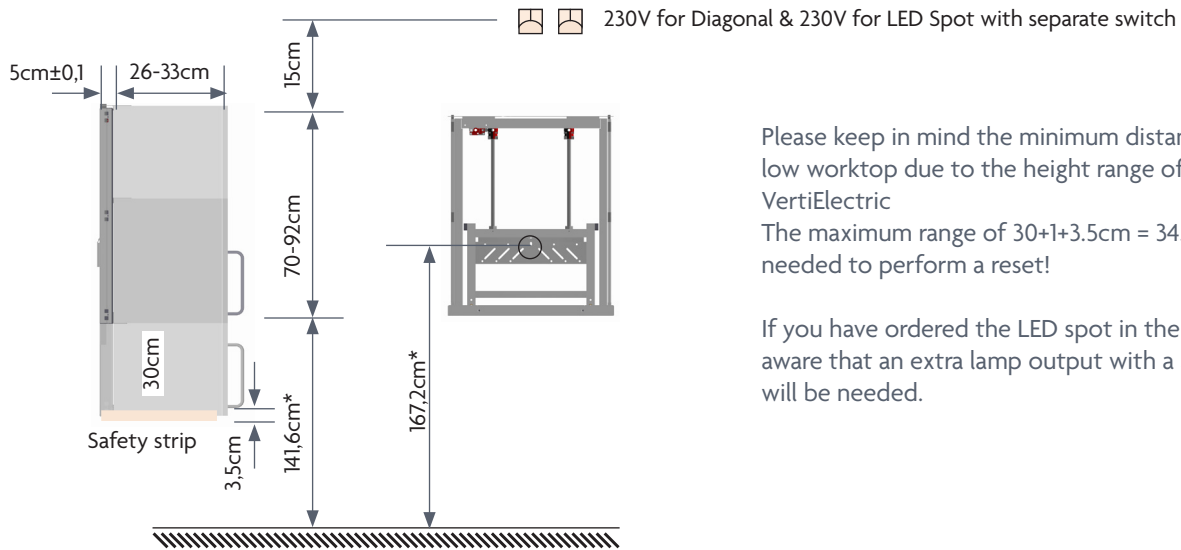

Please keep in mind the minimum distance to the below worktop due to the height range of the Vertielectric
The maximum range of $30+1+3.5\text{cm} = 34.5\text{cm}$ clear space needed to perform a reset!

If you have ordered the LED spot in the Safety Stop, be aware that an extra lamp output with a separate switch will be needed.

* For example

	VERTIELECTRIC	PART NO.	PCS.
	<input type="checkbox"/> Vertielectric, Cabinet width 40 cm	30-40604	
	<input type="checkbox"/> Vertielectric, Cabinet width 50 cm	30-40605	
	<input type="checkbox"/> Vertielectric, Cabinet width 60 cm	30-40606	
	<input type="checkbox"/> Vertielectric, Cabinet width 70 cm	30-40607	
	<input type="checkbox"/> Vertielectric, Cabinet width 80 cm	30-40608	
	<input type="checkbox"/> Vertielectric, Cabinet width 90 cm	30-40609	
	<input type="checkbox"/> Vertielectric, Cabinet width 100 cm	30-40610	
	<input type="checkbox"/> Vertielectric, Cabinet width 110 cm	30-40611	
	<input type="checkbox"/> Vertielectric, Cabinet width 120 cm	30-40612	
	<input type="checkbox"/> Vertielectric, Cabinet width 130 cm	30-40613	
	<input type="checkbox"/> Vertielectric, Cabinet width 140 cm	30-40614	
	<input type="checkbox"/> Vertielectric, Cabinet width 150 cm	30-40615	
	<input type="checkbox"/> Vertielectric, Cabinet width 160 cm	30-40616	
	<input type="checkbox"/> Vertielectric, Cabinet width 170 cm	30-40617	
<input type="checkbox"/> Vertielectric, Cabinet width 180 cm	30-40618		
ACCESSORIES, SEE DIAGONAL PAGE 15 AND 16			

KITCHEN ORDER FORM

ROPOX 4SINGLEELECTRIC

4SingleElectric is a freestanding 4 leg table with lifting height 30cm. Starting height 55 cm or 65 cm + tabletop thickness. Always order the tabletop size in the optional ratio of length / width at intervals of 1 cm. Minimum 60x60 cm to max. 200x300cm. The table frame is delivered by default 0.4 cm shorter than the table top. If a larger overhang of the table top in relation to the table frame is desired, please enclose a drawing of the order.

When ordering, always specify the table top length x width.

The table frame is supplied with control box and operating button H6 x W3 cm.

We always recommend ordering a Safety Strip (see Safety Accessory).

It is possible to reduce the stroke of 4SingleElectric by 1 cm increments. This must be ordered with the total order. (Accessory)

Standard frame colour: Dark grey structure RAL 7021

Detailed information can be found in the "Installation instructions"

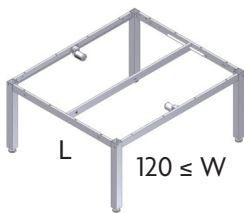

When the table top width is greater than 120 cm, a crossbar is inserted

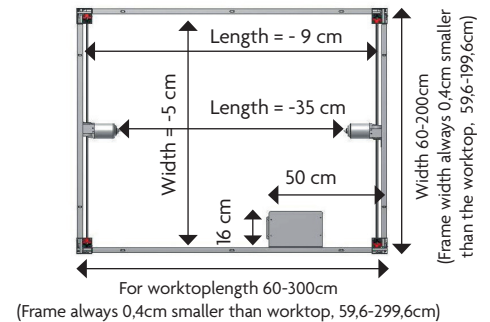

		4SINGLEELECTRIC, HEIGHT 55-85CM WITHOUT WORKTOP	PART NO.	PCS.
	<input type="checkbox"/>	4SingleElectric 60-200 x 60-200cm	50-41020	
	<input type="checkbox"/>	4SingleElectric 201-300 x 60-200cm	50-41021	
	!! Please state the Length and Width of the worktop for H=55-85cm		L	W
		4SINGLEELECTRIC, HEIGHT 65-95CM WITHOUT WORKTOP	PART NO.	PCS.
	<input type="checkbox"/>	4SingleElectric 60-200 x 60-200cm	50-41022	
	<input type="checkbox"/>	4SingleElectric 201-300 x 60-200cm	50-41023	
	!! Please state the Length and Width of the worktop for H=65-95cm		L	W
		ACCESSORY FOR 4SINGLEELECTRIC	PART NO.	PCS.
	<input type="checkbox"/>	4SingleElectric, 220V, Leg. Height 55-85 cm, Improved lifting capacity max. Load 250Kg, Factory fitted	50-41320	
	<input type="checkbox"/>	4SingleElectric, 220V, Leg. Height 65-95 cm, Improved lifting capacity max. Load 250Kg, Factory fitted	50-41420	
	<input type="checkbox"/>	Battery solution, fast height adjustment (standard solution)	50-47025	
	<input type="checkbox"/>	Battery solution, slow height adjustment (Only with increased lifting capacity)	50-47026	
	<input type="checkbox"/>	Safety Strip – see Accessory for FlexiElectric, FlexiElectricCorner & 4SingleElectric If Safety Strip is preferred on 4SingleElectric, this has to be ordered.	50-47027	
<input type="checkbox"/>	Re-programming for limiting the height range to less than 30cm.	30-66010		

KITCHEN ORDER FORM

ROPOX 4SINGLEMANUAL

4SingleManual is a freestanding 4 leg table with lifting height 30cm. Starting height 55 cm or 65 cm + tabletop thickness. Always order the tabletop size in the optional ratio of length / width at intervals of 1 cm. Minimum 60x60 cm to max. 200x300cm.

The table frame is delivered by default 0.4 cm smaller / shorter than the table top. If a larger overhang of the table top in relation to the table frame is desired, please enclose a drawing of the order.

When ordering, always specify the table top length x width.

The table frame is supplied with control box and operating button H6 x W3 cm.

We always recommend ordering a Safety Strip (see Safety Accessory).

It is possible to reduce the stroke of 4SingleElectric by 1 cm increments. This must be ordered with the total order. (Accessory)

Standard frame colour: Dark grey structure RAL 7021

Detailed information can be found in the "Installation instructions"

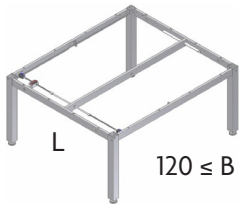

When the table top width is greater than 120 cm, a crossbar is inserted

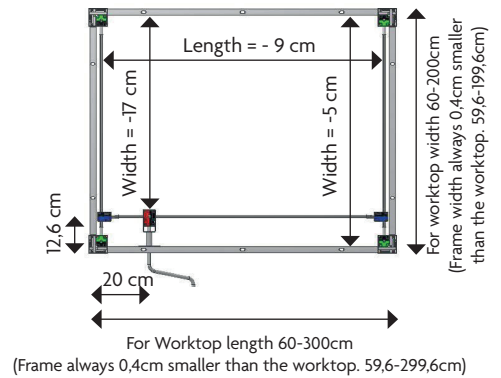

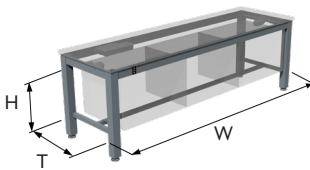

	4SINGLEMANUAL, HEIGHT 55-85CM WITHOUT WORKTOP	PART NO.	PCS.
	<input type="checkbox"/> 4SingleManual 60-200 x 60-200cm	50-41010	
	<input type="checkbox"/> 4SingleManual 201-300 x 60-200cm	50-41011	
	!! Please state the Length and Width of the worktop for H=55-85cm	L	W
	4SINGLEMANUAL, HEIGHT 65-95CM WITHOUT WORKTOP	PART NO.	PCS.
	<input type="checkbox"/> 4SingleElectric 60-200 x 60-200cm	50-41012	
	<input type="checkbox"/> 4SingleManual 201-300 x 60-200cm	50-41013	
	!! Please state the Length and Width of the worktop for H=65-95cm	L	W

KITCHEN ORDER FORM

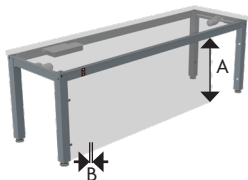
	ACCESSORY FOR 4SINGLEELECTRIC & MANUAL	PART NO.		PCS.
	<input type="checkbox"/> Special adaptation for cabinets (additional price)	50-41030		
	!! Please state the Width, depth and height of the cabinets	Total Width: W	Depth: D	Height: H

	ACCESSORY FOR 4SINGLEELECTRIC & MANUAL	PART NO.		PCS.
	<input type="checkbox"/> Mounting brackets for concealment panel (4 pcs. for one side), one side. Additional price. Concealment panel not included.	50-41031		
	!! Please state thickness of the concealment panel and pcs.	Panel height: A		
		Panel thickness: B		

	ACCESSORY FOR 4SINGLEELECTRIC & MANUAL	PART NO.		PCS.
	<input type="checkbox"/> Brake wheels, Grey, increase the table height by 6.5cm. 4 pcs.	50-41600		
	<input type="checkbox"/> Floor fittings to fix the table to the floor. 4 pcs.	50-41605		

KITCHEN ORDER FORM

OWN NOTES
