

Ropox Mobilio Showerbed



User manual

This manual should always be in close proximity of the product.

Table of content

1. Symbols used in this manual	4
2. General Safety	4
2.1 Product label	6
3. General requirements	7
3.1 Product information	7
3.2 Intended use.....	8
3.3 Intended operator	8
3.4 Known contraindications	8
3.5 Dimensions.....	9
4. Instructions for use	10
4.1 Product assembly	10
4.1.1 Assembly of legs	10
4.1.2 Connection of wires in the controlbox	10
4.2 Operating the product	11
4.2.1 Actuation of the product.....	11
4.2.2 Activation and release of brake systems.....	11
4.2.3 Operation of the bed guards.....	12
4.2.4 Safety in use	12
4.2.5 Ambient temperature	12
4.3 Battery, detachable	14
5. Cleaning	18
6. Maintenance	19
6.1 Periodic maintenance of bed guards	19
6.2 Periodic charging of battery	19
6.3 Replacement of battery.....	19
6.4 Fault finding	19
6.5 Calibration of lifting columns.....	19
7. Environmental protection	20
8. Spare parts	20
9. Accessories	21
9.1 Battery, detachable	22
9.2 Central locking wheels.....	22
9.3 Backrest (After/Pre)	23
9.4 Bed guard, end	23
10. Electromagnetic compatibility	24
10.1 Suitable Environments.....	24
10.2 Basic safety and Essential performance	24
10.3 Adjacent and stacked use.....	24
10.4 Cables.....	24
10.5 RF portable equipment	24
10.6 Compliance for emission and immunity standard.....	24
10.6.1 Emission class and group.....	24
10.6.2 Immunity test levels	25

1. Symbols used in this manual

Warning Symbol Indication of potentially hazardous situation. If not avoided, it can result in serious injury or death.	
Caution Symbol Indication of potentially hazardous situation which may result in minor or moderate injury. It may also be used to alert against unsafe practices.	
Notification Symbol This symbol is used to notify correct use and handling of the product.	

2. General Safety

	<p>This manual must be read and understood before use. Always keep this manual in close proximity of the product.</p> <p>The use, installation and service of this product must be in compliance with this manual to avoid accidents and serious personal injury.</p> <p>Never use or handle this product in other ways specified in this manual as it can result in personal safety hazards and/or cause damage to the product.</p> <p>Persons installing and/or are using this product either as operator or patient should have the necessary safety information and access to this manual.</p>
---	--



Always comply with instructions in this manual to avoid damaging or destroying the product. Not doing so can cause the safety of this product to be compromised.

Before putting the product into use, make sure the stability of the product is intact.

Do not perform repairs, disassembly or assembly operations, add-ons, re-adjustments or modification of the product beyond what is described in this manual. All spare parts must be Ropox designated parts.

Repairs must be carried out by Ropox or Ropox authorized personnel. Do not perform service while in use with a patient.

Do not allow children to operate this product unless they are under supervision from an adult that has read and understood this manual. The product is not intended to play with.

Do not use the product if it has defects or have become damaged before being repaired or replaced.











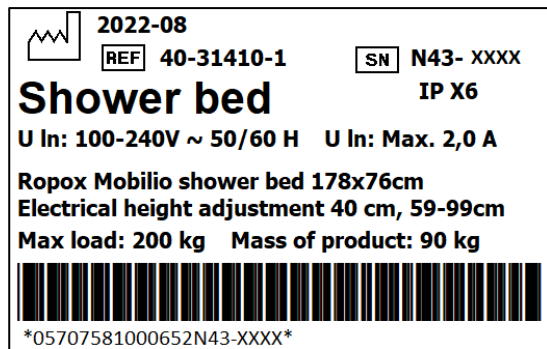
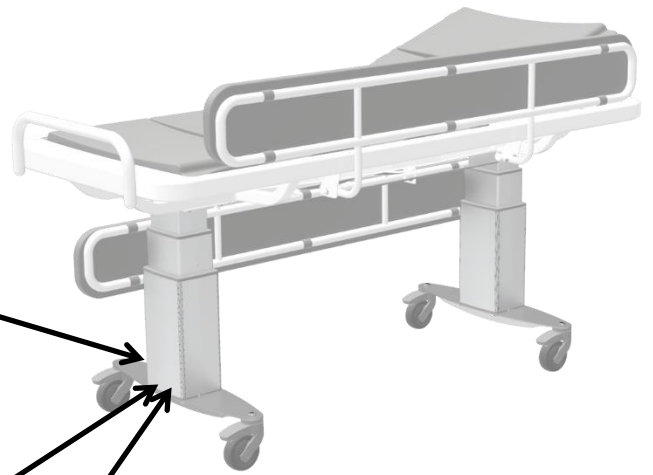





The information in this manual is based on correct installation in accordance with installation instructions for this product.

Ropox cannot be held liable if the product is used in any way that differs from stated in this manual and/or installation instruction.

Ropox reserve the right to amend this manual and reference documents without prior notice.

2.1 Product label



	<p>This product is UKCA-marked in accordance with:</p> <p>UK SI 2002 No. 618 - <i>The Medical Devices Regulations 2002</i>, and its amendments</p>
	<p>This product is CE-marked in accordance with:</p> <p>European Medical Device Regulation (EU)2017/745 Council Directive 2011/65/EU, RoHS</p> <p>The product also conforms to:</p> <p>European Medical Device Directive 93/42/EEC, including amendments incorporated in Directive 2007/47/EEC.</p>
	<p>Manufacturer name and address</p>
	<p>Date of production</p>
	<p>Stock number</p>
	<p>Serial number</p>
	<p>Operating interval of electrically operated equipment. The use of electrical height adjustable equipment can run at maximum 2 minutes, followed by an 18-minute break.</p>
	<p>Type BF applied part. The product complies with IEC 60601-1 requirements to provide protection against electric shock.</p>
	<p>Consult manual for important safety related information, warnings and safety precautions.</p>
	<p>Class II, double isolated electrical components.</p>
	<p>Do not dispose as unsorted municipal waste. Product must be returned to a designated recycling station.</p>
	<p>Operating and storing temperatures may not exceed -5 °C to 40 °C</p>
	<p>Consult manual before use</p>

3. General requirements

3.1 Product information

Manufacturer	Ropox A/S Ringstedgade 221 DK-4700 Naestved +45 55 75 05 00 info@ropox.com	UK Responsible Person	Qserve Group UK, Ltd 49 Greek Street, W1D 4EG London United Kingdom +44 740 885 936 3 info@qservegroup.com
Product models	Part number	Model	Configuration
	40-31406-1	Mobilio Shower Bed 146x76 cm	Standard lockable wheels and bedguards
	40-31410-1	Mobilio Shower Bed 178x76 cm	
	40-31411-1	Mobilio Shower Bed 210x76 cm	
MDR Class (EU) 2017/745	Class I		
Applied part classification 60601-1	Type BF applied part		
Protection Class 60601-1	Class II		
Expected lifetime	5 years		
Height adjustment	59-99 cm		
Speed of actuation	≈ 18 mm/s		
Maximum user weight according to ISO 17966:2016	200 kg		
Power supply	100-240 V ~ 50/60 Hz		
I in	Max 2.0 A		
Intermittence	2 min use / 18 min pause		
IP rating	IPX6		
Ambient temperature range	-5 °C to +40 °C Transport and storage (battery included) -10 °C to +50 °C Transport and storage (without battery) +5 °C to +40 °C Operation		
Relative humidity:	20% to 80% - non-condensing		
Atmospheric pressure	700 hPa to 1060 hPa		
Materials in contact with patient	Tub	ABS/PMMA	
	Cushion for bed guard	Dahlia fabric Backing: 100% polyester Coating: 100% Polyurethane ISO 10993-10 Non Allergic	
	Bed guard	St37 tube steel, powder coated	
	Slats	PUR FLEX 200	
Intended environments	This product is to be used in: Professional healthcare Facility Homecare healthcare Environment <i>As defined by IEC 60601-1-2</i> <i>The product is not intended for use during HF surgery.</i>		

Accessories	BA19 Lead acid battery 40-30762	<p>Specification</p> <ul style="list-style-type: none"> • Lead acid technology: Lead acid • Expected lifetime 4 years • Output voltage: 24 V DC • Max. discharge current: 6 A • Charging current: 300 mA, controlled by BA19 internal charger • Capacity: 1.2 Ah / 28.8 Wh • Weight: 1.6 kg <p>Usage</p> <ul style="list-style-type: none"> • Compatibility: Battery backup for CA30/CA40 and CO61 • Duty cycle: 10%, 2 minutes continuous use followed by 18 minutes not in use • Charging: Via integrated charger • Charging time: Approx. 6 hours • Recharging during storage: Battery recharging no later than 6 months after production date stated on the label • Operating temperature: +5 °C to +40 °C • Storage temperature: -5 °C to +40 °C <p>The batteries must be stored in an applicable storage room to avoid direct sunlight</p> <ul style="list-style-type: none"> • Relative humidity: 20% to 80%, but non-condensing acc. to temp. • Atmospheric pressure: 700 hPa to 1060 hPa • Service: Battery cells cannot be replaced as the battery cover cannot be closed properly afterwards
	Cushion for bed guard 40-25782-1 40-25783-1	<p>For L= 146 cm For L= 178 cm, 210 cm</p>
	Central brake system 40-30765-1 40-30764-1 40-30766-1	<p>For L= 146 cm For L= 178 cm For L= 210 cm</p>
	Bed guard, end 40-25038	<p>For all sizes</p>

3.2 Intended use

The mobile height adjustable shower bed can be used to nurse children and adults up to 200 kg. The shower bed is intended for use in private homes, day-care centers, day centers for persons with physical or mental disabilities, or similar institutions, to provide the right and optimal working conditions for the staff. The mobile shower bed can be used in both dry and wet rooms. The shower bed is freestanding, mobile and with brake wheels to ensure optimum working conditions.

The height of the work surface can be adjusted step less from 59-99cm using a spiral cord handset.

3.3 Intended operator

Reading and understanding this manual will be sufficient training for an intended operator. Children under the age of 16 or patient are not considered intended operator.

3.4 Known contraindications

There is no known contraindication for this product.

3.5 Dimensions

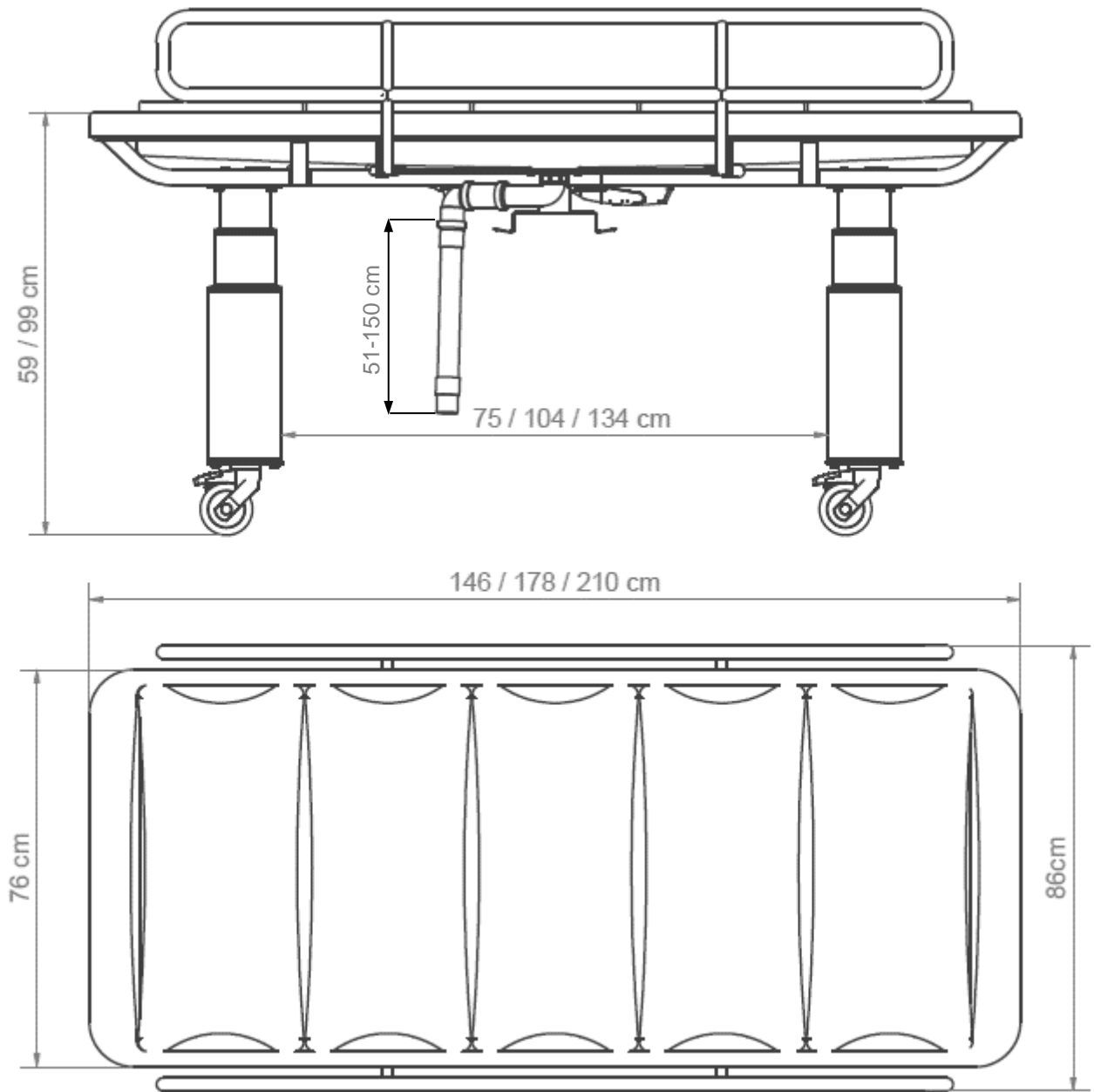

4. Instructions for use

4.1 Product assembly

4.1.1 Assembly of legs

Mount the legs with 8x enclosed M8 bolts. It is recommended to cross tighten the 4 bolts, on each leg assembly.

	Note! Remember to use locking shims! All bolts are tightened with a torque of 12Nm / 8.9ft/lbs
---	---

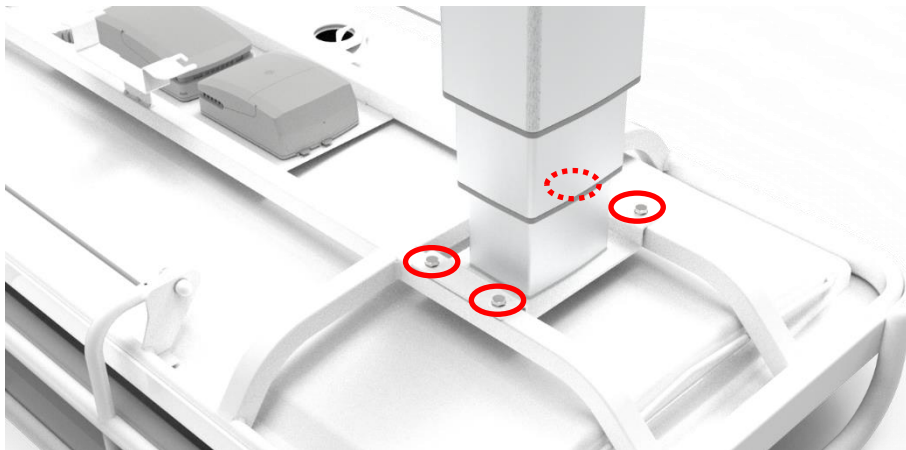

4.1.2 Connection of wires in the controlbox

Wires are connected according to picture and designation shown below.

A	Motor cable 1
B	Motor cable 2
C	Handset
D	Battery (accessory)

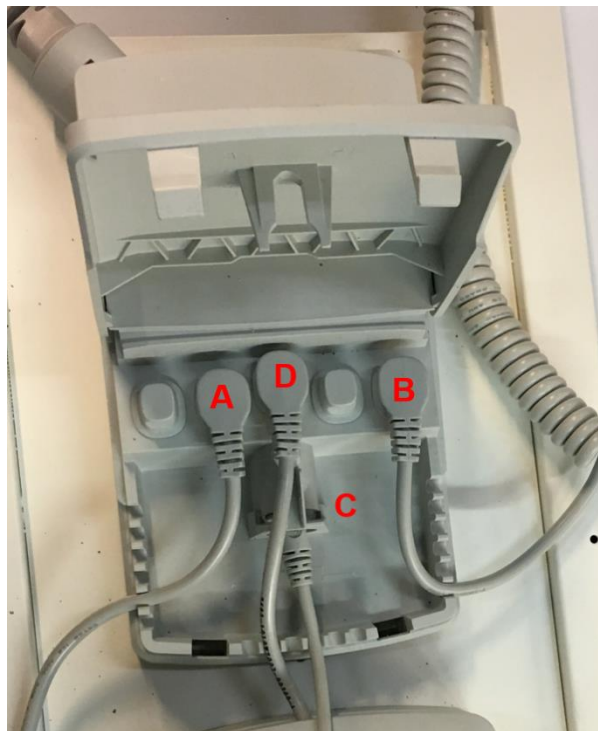

	Note! All wires are sealed with O-rings, make sure these are fully engaged by pushing the connectors firmly to the bottom of the socket.
---	--

4.2 Operating the product



Warning!

Before use always make sure that mains cable and hand control cable will be able to travel freely without the risk of squeezing or disconnecting the product as result of the movement.



Caution!

When connected to the mains the product must be placed in a manner according to power outlets so that the operator will be able to disconnect the product during use in case of an emergency.

4.2.1 Actuation of the product

The product is operated with the spiral cord hand control. Arrow up will move the product upwards, and arrow down will move the product downwards.

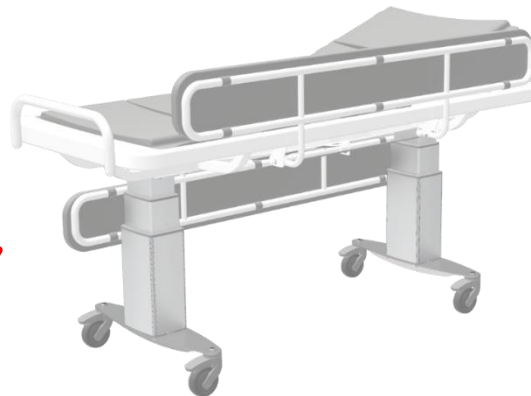

Warning!

The product should always be able to travel the full range of actuation without colliding with objects. Failing to do so will compromise the product stability and introduce risk of squeezing body parts. Special care should be taken in ensuring that no children or adults are sited under the product as severe injury from entrapment may occur.

4.2.2 Activation and release of brake systems

To activate the brake wheels, use appropriated foot pad.



Caution!

The central brake system or standard locking brakes must always be locked and secure before a patient is placed on the product.

Check function before use!

The product is not intended as a mean for patient transportation and the use of it must only be stationary.

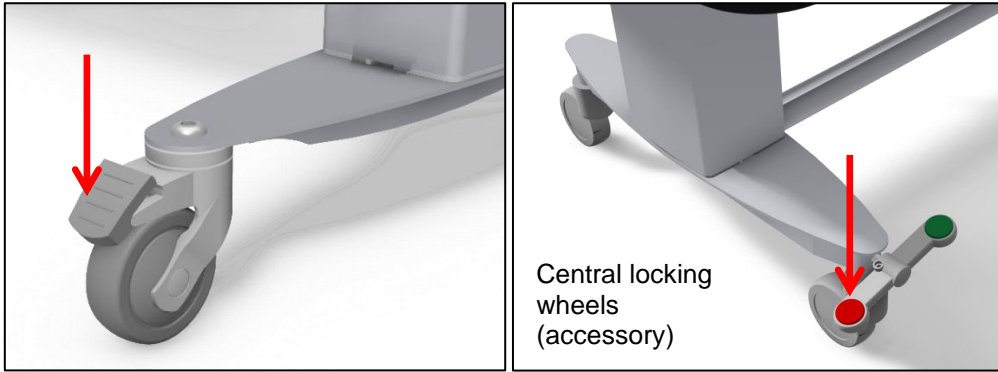

4.2.3 Operation of the bed guards

Mobilio Showerbed is always supplied with bed guards.

To operate the bed guards, pull the rubber tubing placed under the tabletop to release the locking mechanism. The bed guard can then be pivoted to the desired mode.

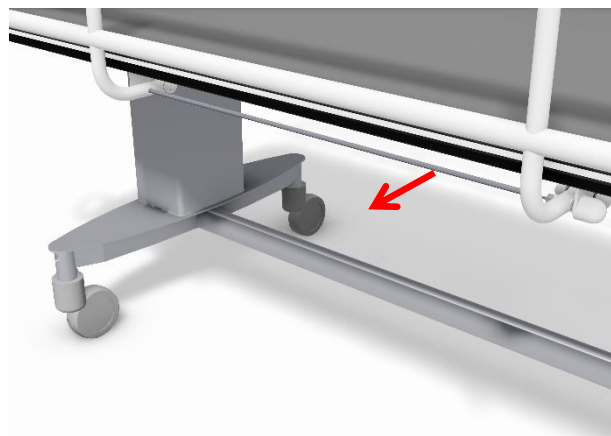

	<p>Warning!</p> <p>Make sure that the bed guard is locked securely in place when in use with a patient. Locking is checked by shaking the bed guard back and forth ensuring that the locking pin is fully engaged.</p>
--	---

	<p>Warning!</p> <p>The bed guard presents a tripping hazard when exiting the product. Keep your eyes on the bed guard when exiting.</p>
--	--

4.2.4 Safety in use

	<p>Warning!</p> <p>Slats may be slippery when applying soap and cause patient to slip on surface. Make sure that the patient is lying down and not stand on the shower bed.</p> <p>Make sure to deploy bed guards when using product with a patient.</p>
--	---

4.2.5 Ambient temperature

Allow the product to reach operational temperature +5-40 °C when stored in temperatures outside this interval.

Storage temperature	Time to reach operational temperature (+5 °C or +40 °C) at 20 °C ambient temperature
-5 °C	3 Hours
+40 °C Battery	0 hours
+50 °C Without battery	3 Hours

4.3 *Battery, detachable*

Mobilio can be operated integrated battery solution with removable battery. This is ordered together with the product and assembled from the factory. Removable battery system can not be ordered post sale.
Item number: **40-30772**

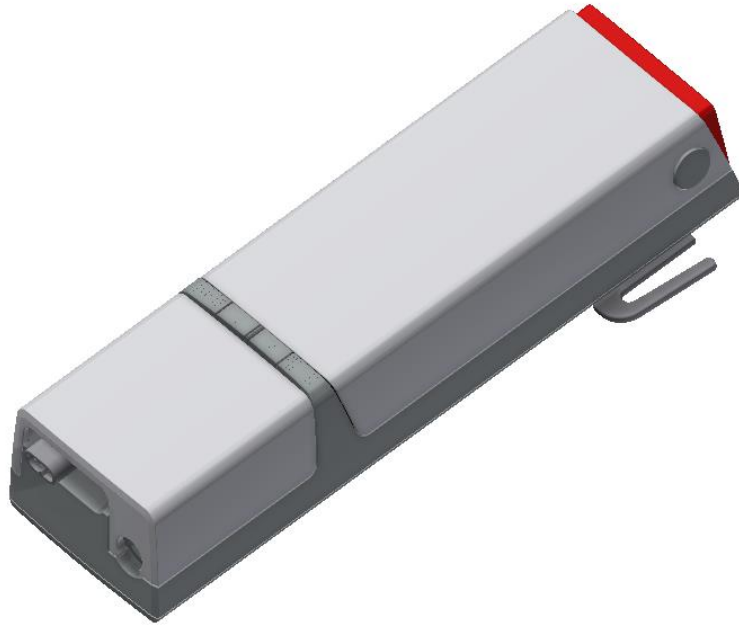

Emergency stop instructions

Emergency stop activation/deactivation: The emergency stop is mounted on top of the BAL50 battery. It is readily available as the norm describes.

Operation to activate emergency stop

- 1) Push button on top of battery

To release emergency stop Take off battery



- 2) Use thumb and index/middle finger to push buttons on battery sides
- 3) Pull battery out

To replace the battery again



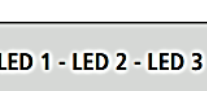

- 4) Grab battery on sides and steer battery base over steering pin.
- 5) Push in place This will release the emergency stop

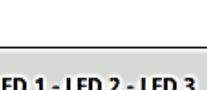
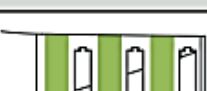

LED Indication

LED 1 - LED 2 - LED 3	LED state (Not listed = off)	States in normal use
	LED 1 - 3 constantly on	75 - 100% SOC
	LED 1 + 2 constantly on	50 - 75% SOC
	LED 1 constantly on	< 50% SOC
	LED 1 left side, switches from green to yellow and flashes slowly	Two cycles left, buzzer active



LED 1 - LED 2 - LED 3	LED state (Not listed = off)	States while charging
	LED 1 - 3 constantly on	90 - 100%
	LED 1 + 2 constantly on LED 3 flashes slowly	65 - 90%
	LED 1 constantly on LED 2 flashes slowly	40 - 65%
	LED 1 flashes slowly	0 - 40%
	LED 1 + 2 + 3 flash slowly	Charging stopped due to low battery temperature, high bat- tery temperature or other error conditions
	No light in LEDs	Charging stopped due to lost communication to battery



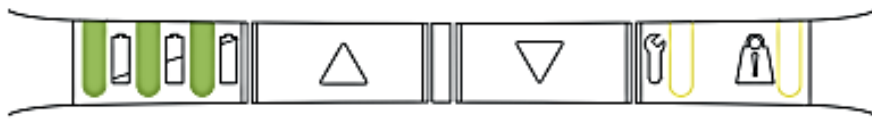

PRIORITY	LED 4 + LED 5	LED state (Not listed = off)	States in normal use	Comments	Reset
0		LED 4 flashing according to BLE pairing state*	Pairing BLE	Not ready to drive	Wait until ready
1		LED 4+5 constantly on	Emergency stop activated	Not ready to drive	Reactivate emergency stop
2		LED 4+5 flashing fast (synchronous)	FATAL ERROR Cannot drive, has to be reset	No movement possible	Reset fatal error routine
3		LED 4+5 flashing slowly (asynchronous toggling)	Not learned/configured correctly	Not ready to drive	Learn device, configure correct
4		LED 5 flashing slowly	OVERLOAD on CH1	Momentary not ready to LIFT	Reduce load
5		LED 4 flashing slowly	Duty cycle guard	Momentary not ready to LIFT	Wait until ready
6		LED 5 constantly on	Position not to be trusted	Drive is possible	Drive into EOS
7		LED 4 constantly on	Service needed	Drive is possible	SDT, App, HB.

5. Cleaning

Cleaning can be done with lukewarm water and a suitable all-purpose cleaning agent. Use a cloth or soft sponge to wash the product. Dry the product off with a wrung cloth.

Cleaning of slats

Lime deposits on slats are removed with a household bathroom cleaning agent.

	<p>Notification! Do not use cleaning agents containing abrasive e.g. scouring powder, steel wool, scouring sponge.</p> <p>This product is not designed to be sterilized, autoclaving and sterilization beyond normal cleaning may possibly change the product safety and function.</p>
---	---

Chemical resistance and disinfection

Detergents containing the following chemicals must not be used for cleaning or disinfection:

Acetone
Ammonium carbonate
Ethyl acetate
Formic acid
Hydrochloric acid
Isopropanol
Methyl acetate
Nitric acid
Phosphoric acid

Pre-approved cleaning agents

Tradename	Solution
Acticlor plus	1000ppm
S90 sanirens	1-3% peracid
FUTUR, Alkalisk rens	1% Solution [pH 9,5]

Disinfection

	<p>Caution! Disinfect the changing between uses to avoid cross contamination</p>
---	---

	<p>Caution! Do not disinfect the product when connected to mains and/or are in use with a patient</p>
---	--

6. Maintenance

	<p>Notification! Failing to comply with periodic maintenance may result of degrading of product function and safety.</p>
---	---

	<p>Notification! Ropox will make parts list and circuit diagrams available for maintenance and repair beyond what is described in this manual. Repair beyond what is described in this manual may only be done by Ropox designated service personnel.</p>
---	--

6.1 Periodic maintenance of bed guards

If the product is used in a humid or dry atmosphere the locking pin may be prone to failure from lubricants drying. Besides checking the function of the locking mechanism before every use, a periodic lubrication of the locking pin every 6 month is recommended.

6.2 Periodic charging of battery

The battery must be periodically charged minimum every 6 months to sustain capacity. If the product is left unused or the battery is disconnected this may result degrading of the battery capacity. Charging the battery minimum every 6 months will mitigate this.

6.3 Replacement of battery

	<p>Notification! The battery is to be replaced after 4 years at the latest.</p>
---	--

6.4 Fault finding

Problem	Check the following
Mobilio does not move up or down when the hand-control switch is pressed	<ol style="list-style-type: none"> 1. The product is connected to 230V and the control box LED indicator lights green 2. Motor cables are connected to control box 3. The control switch has been connected with the control unit 4. If the product is used with battery, check whether it is charged. 5. The motors are overloaded (note: 2 min. ON, 18 min OFF).
Control switch defective	<ol style="list-style-type: none"> 1. Order a new control switch
Mobilio is not horizontal / level	<p>"Reset" Press and hold UP (▲) and DOWN (▼) buttons. Keep the buttons depressed until the control unit has beeped approx. ten times. After that, the product may be adjusted to the bottom position for resetting.</p>

6.5 Calibration of lifting columns

Lifting columns are aligned and calibrated from the factory. In case they need calibration to run simultaneously use the **"Reset"** procedure.

7. Environmental protection

The product is not intended to be disposed as municipal waste. Proper disassembly, sorting and disposal of components must be done by waste disposal professionals.



Part	Disposal recommendation
Tub	Hard plastic
Slats	Soft plastic
Bed guards	Steel waste
Frame and wheel assembly	Steel waste
Control box	Electronics
Lifting columns	Aluminum or electronic waste
BA19 battery	Lead acid battery waste

8. Spare parts

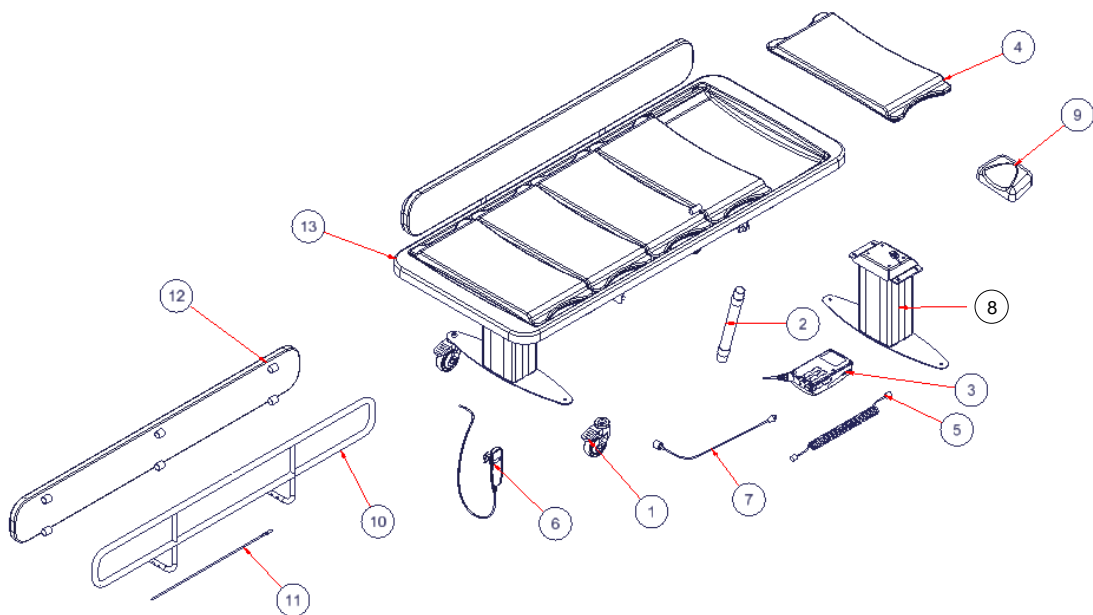

#	Name	Part number
1	Brake wheels	40-30200-1
2	Flex. Tubing Ø40, white	97001159
3	Control box CO61	97001720
4	Slats	40-25030-2
5	Motor cable	97001724
6	Control switch	97001655
7	Power cable	97000427
8	Lifting column incl. bracket	40-31201-1
9	Headrest	40-25090-1

#	Name	40-31406	40-31410	40-31411
10	Bed guard complete	40-31196-1	40-31197-1	40-31197-1
11	Spare parts for bed guard	40-30198-1	40-30199-1	40-30199-1
12	Cushion for bed guard	40-25782-1	40-25783-1	40-25783-1
13	Tub	40-40090-060	40-40090-061	40-40090-062

*Bed guard complete contains necessary spare parts for assembly

Central locking wheels (accessory)

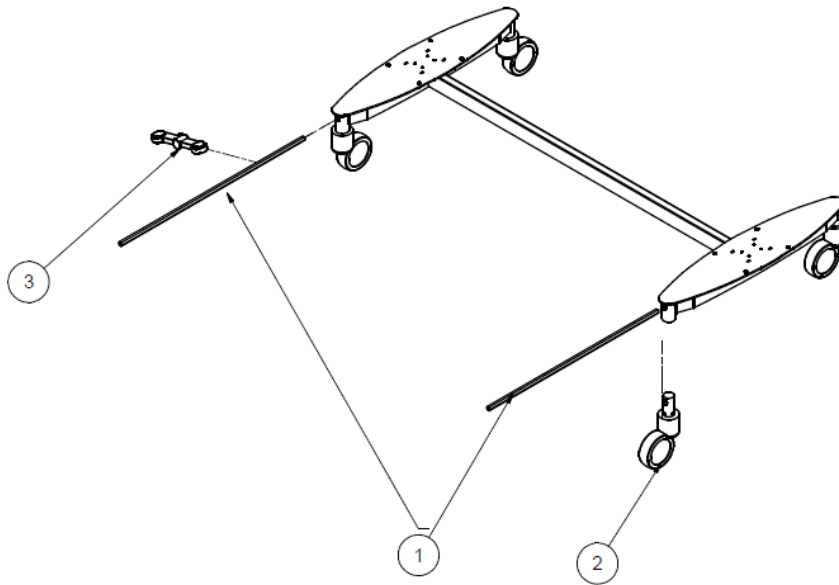

#	Name	Part number
1	Axles for central locking wheels	40-30190-1
2	Wheels with. central brake Ø100	97003067
3	Lock pedal, red and green button	97003068

9. Accessories

A number of configuration options are available. Such options are generally ordered and delivered installed on the product at first delivery.



Warning!

Only qualified personnel may perform aftermarket installation of spare parts and accessories.



Caution!

Do not use accessories or spare parts other than those specified for the product.

9.1 Battery, detachable

Mobilio can be operated integrated battery solution with removable battery. This is ordered together with the product and assembled from the factory. Removable battery system can not be ordered post sale.
Item number: 40-30772

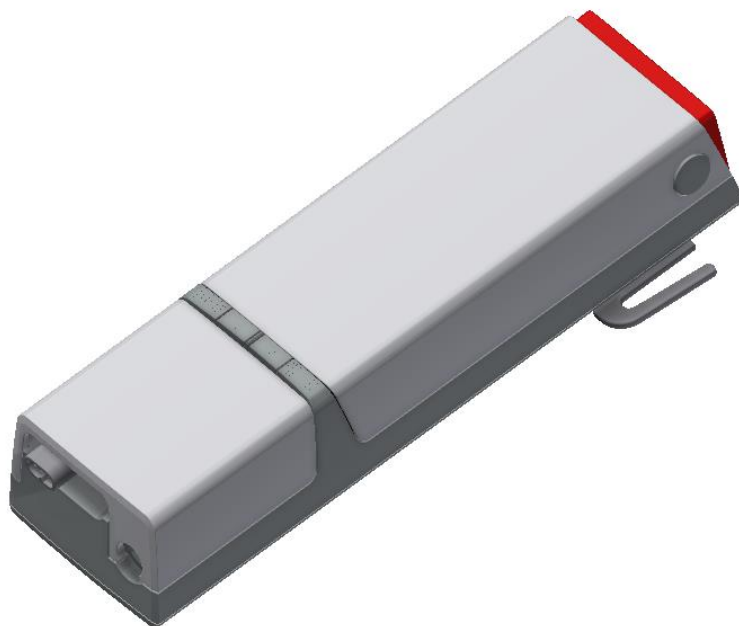

9.2 Central locking wheels



Part number	Size	QTY
40-30765-2	L= 146 cm	1
40-30764-2	L= 178 cm	1
40-30766-2	L= 210 cm	1

9.3 Backrest (After/Pre)

Shipped separately. Includes 2 extra slats.
Part number: **40-25031**

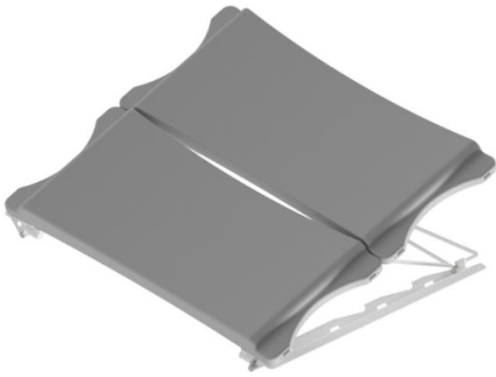

Pre-mounted at factory.
Part number: **40-25032**

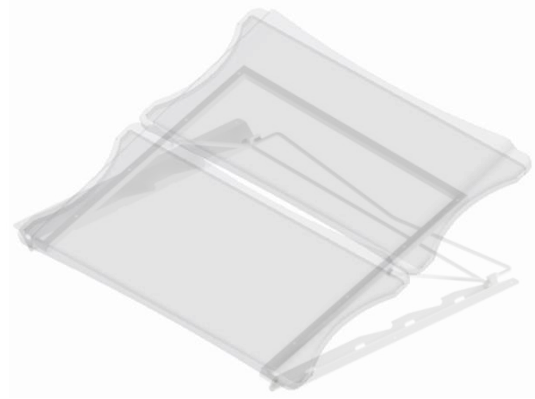

9.4 Bed guard, end

Part number: **40-25038**



10. Electromagnetic compatibility

10.1 Suitable Environments

The device is suitable for use at home, at daycare centers, at day centers for persons with physical or mental disabilities or at hospitals except near active HF surgical equipment and the RF shielded room of a medical electrical system for magnetic resonance imaging, where the intensity of electromagnetic disturbances is high.

10.2 Basic safety and Essential performance

The device does not have any function related to basic safety or essential performance. In case of loss or degradation of performance, the user can get on and off the product.

10.3 Adjacent and stacked use

	<p>Warning !</p> <p>Use of this equipment adjacent to or stacked with other equipment should be voided because it could result in improper operation. If such use is necessary, this equipment and the other equipment should be observed to verify that they are operating normally.</p>
---	--

10.4 Cables

Cable component	Length
Power cable	3,2m
Hand control spiral cable	Approx. 5m extended.

	<p>Warning!</p> <p>Use of accessories, transducers and cables other than those specified or provided by the manufacturer of this could result in increased electromagnetic emissions or decreased electromagnetic immunity of this equipment and result in improper operation.</p>
---	---

10.5 RF portable equipment

	<p>Warning !</p> <p>Portable RF communications equipment (including peripherals such as antenna cables and external antennas) should be used no closer than 30 cm (12 inches) to any part of the device, including cables specified by the manufacturer. Otherwise, degradation of the performance of this equipment could result.</p>
---	---

10.6 Compliance for emission and immunity standard

The product is tested and found compliant for EMC according to EN60601-1-2:2015 for Clause 7 and Clause 8. Documentation is tested and found compliant according to EN60601-1-2:2015 for Clause 5

10.6.1 Emission class and group

Phenomenon	Test method	Class	Group
Conducted RF emissions	EN 55011	Class B	Group 1
Radiated RF emissions	EN 55011	Class B	Group 1
Harmonic current emissions	EN 61000-3-2	Class A	-
Voltage changes, voltage fluctuations and flicker emissions	EN 61000-3-3	-	-

10.6.2 Immunity test levels

Phenomenon	Test method	Immunity test level
Electrostatic discharge immunity	EN 61000-4-2	+/- 8 kV contact +/- 2, 4, 8, 15 kV air
Electrostatic discharge immunity – I/O SIO/SOP ports	EN 61000-4-2	+/- 8 kV contact, +/- 2, 4, 8, 15 kV air Connectors shall be tested. Do not test pins, as they cannot be contacted or touched, under conditions of intended use.
Radiated RF electromagnetic field immunity	EN 61000-4-3	10 V/m 80 MHz to 800 MHz 20 V/m 800 MHz to 2.5 GHz 10 V/m 2.5 GHz to 2.7 GHz 80 % AM 1 kHz
Immunity to proximity fields from RF wireless communication equipment	EN 61000-4-3	385 MHz, 27 V/m, 18 Hz PM (50 % duty cycle square wave) 450 MHz, 28 V/m, FM +/- 5 kHz dev., 1 kHz sine 710 MHz, 9 V/m, 217 Hz PM (50 % duty cycle square wave) 745 MHz, 9 V/m, 217 Hz PM (50 % duty cycle square wave) 780 MHz, 9 V/m, 217 Hz PM (50 % duty cycle square wave) 810 MHz, 28 V/m, 18 Hz PM (50 % duty cycle square wave) 870 MHz, 28 V/m, 18 Hz PM (50 % duty cycle square wave) 930 MHz, 28 V/m, 18 Hz PM (50 % duty cycle square wave) 1720 MHz, 28 V/m, 217 Hz PM (50 % duty cycle square wave) 1845 MHz, 28 V/m, 217 Hz PM (50 % duty cycle square wave) 1970 MHz, 28 V/m, 217 Hz PM (50 % duty cycle square wave) 2450 MHz, 28 V/m, 217 Hz PM (50 % duty cycle square wave) 5240 MHz, 9 V/m, 217 Hz PM (50 % duty cycle square wave) 5500 MHz, 9 V/m, 217 Hz PM (50 % duty cycle square wave) 5785 MHz, 9 V/m, 217 Hz PM (50 % duty cycle square wave)
Electrical fast transient/burst immunity – AC power ports	EN 61000-4-4	+/- 2 kV 100 kHz repetition frequency
Electrical fast transient/burst immunity – I/O SIO/SOP ports	EN 61000-4-4	+/- 1 kV 100 kHz repetition frequency
Surge immunity – AC power ports	EN 61000-4-5	Line-to-line: +/- 0.5, 1 kV line to line Line-to-ground: Not applicable, the device is a Class II device
Immunity to conducted disturbances induced by RF fields – AC power ports	EN 61000-4-6	3 V (6 V in ISM bands and amateur radio bands) 0.15-80 MHz 80 % AM 1 kHz
Immunity to conducted disturbances induced by RF fields – I/O SIO/SOP ports	EN 61000-4-6	3 V (6 V in ISM bands and amateur radio bands) 0.15-80 MHz 80 % AM 1 kHz
Power frequency magnetic field immunity	EN 61000-4-8	30 A/m 50 Hz and 60 Hz Test as tabletop equipment, for at least 1 minute in each direction
Voltage dips, short interruptions, and voltage variations immunity	EN 61000-4-11	0 % U _T ; 0.5 cycle at 0°, 45°, 90°, 135°, 180°, 225°, 270° and 315° 0 % U _T ; 1 cycle at 0° 70 % U _T ; 10 cycles at 0° 0 % U _T ; 250 cycles at 0°
a) The ISM (industrial, scientific and medical) bands between 0.15 MHz and 80 MHz are 6.765 MHz to 6.795 MHz; 13.553 MHz to 13.567 MHz; 26.957 MHz to 27.283 MHz; and 40.66 MHz to 40.70 MHz. The amateur radio bands between 0.15 MHz and 80 MHz are 1.8 MHz to 2.0 MHz. 3.5 MHz to 4.0 MHz. 5.3 MHz to 5.4 MHz. 7 MHz to 7.3 MHz. 10.1 MHz to 10.15 MHz. 14 MHz to 14.2 MHz. 18.07 MHz to 18.17 MHz. 21.0 MHz to 21.4 MHz. 24.89 MHz to 24.99 MHz. 28.0 MHz to 29.7 MHz and 50.0 MHz to 54.0 MHz.		

11. Complaints

See our general terms of sale and delivery on www.ropox.com



ROPOX A/S

Ringstedgade 221
DK – 4700 Næstved

Tel.: +45 55 75 05 00 Fax.: +45 55 75 05 50

E-mail: info@ropox.dk

www.ropox.com